

DECdfs for OpenVMS

Management Guide

January 1999

Software Version: DECdfs for OpenVMS Version 2.3
Operating System and Version: OpenVMS Alpha Version 6.2, 7.1, and 7.2
OpenVMS VAX Version 5.5-2, 6.2, 7.1, and 7.2

Compaq Computer Corporation
Houston, Texas

January 1999

Compaq Computer Corporation makes no representations that the use of its products in the manner described in this publication will not infringe on existing or future patent rights, nor do the descriptions contained in this publication imply the granting of licenses to make, use, or sell equipment or software in accordance with the description.

Possession, use, or copying of the software described in this publication is authorized only pursuant to a valid written license from Compaq or an authorized sublicensor.

Compaq conducts its business in a manner that conserves the environment and protects the safety and health of its employees, customers, and the community.

© Compaq Computer Corporation 1999. All rights reserved.

The following are trademarks of Compaq Computer Corporation: Alpha, Compaq, DECdfs, DECdirect, DECdns, DECnet, DIGITAL, OpenVMS, VAX, VAX DOCUMENT, VMS, and the Compaq logo.

The following is a third-party trademark:

MS-DOS is a registered trademark of Microsoft Corporation.

All other trademarks and registered trademarks are the property of their respective holders.

ZK6548

The OpenVMS documentation set is available on CD-ROM.

Contents

Preface	vii
1 Introduction to DECdfs	
1.1 Components of a DECdfs Environment	1-3
1.1.1 Digital Distributed Name Service	1-3
1.1.2 Access Points	1-4
1.1.3 DECdfs Management Components	1-6
1.1.3.1 The Server	1-7
1.1.3.2 The Client	1-7
1.1.3.3 The Communication Entity	1-7
1.2 Client-Server Consistency Issues	1-9
1.2.1 System Times on the Client and Server	1-9
1.2.2 Logical Names on the Client and Server	1-9
1.3 Comparison of Standard OpenVMS File Access and DECdfs File Access	1-9
1.4 The DFSSCONTROL Commands	1-12
1.4.1 Using DFSSCONTROL Commands in DECdfs Command Files	1-13
1.4.2 Using DFSSCONTROL Commands Interactively	1-14
1.4.3 Getting Help with DECdfs	1-14
2 Managing a DECdfs Server	
2.1 Setting System Parameters	2-1
2.1.1 Limiting the Number of Open Files	2-2
2.1.2 Controlling DECdfs Activity	2-2
2.1.3 Limiting Inactive DECdfs DECnet Links	2-3
2.2 Setting Up Proxy Accounts	2-3
2.2.1 Setting Up Privileges	2-5
2.2.2 Setting Up UICs, ACLs, and User Names	2-5
2.2.2.1 User Identification Codes	2-5
2.2.2.2 Access Control Lists	2-6
2.2.2.3 User Names	2-6
2.2.3 Giving Cluster Clients Access to Server Files	2-6
2.2.4 Allowing Client Users to Print Server Files	2-7
2.3 Creating and Managing Access Points	2-8
2.3.1 Deciding Where to Place Access Points	2-8
2.3.2 Adding Access Points	2-10
2.3.2.1 Systems with DECdns	2-11
2.3.2.2 Systems Without DECdns	2-12
2.3.2.3 Using the /LOCAL Qualifier	2-13
2.3.3 Determining Access Point Information	2-14
2.3.4 Changing Access Points	2-14

2.3.5	Removing Access Points Added with the /CLUSTER_ALIAS Qualifier	2-14
2.3.6	Maintaining Consistency with DECdns	2-15
2.4	Protecting Server Files	2-16
2.5	Protecting Individual Files	2-16
2.6	Managing the Persona Cache	2-16
2.6.1	Specifying the Lifetime of Persona Blocks	2-17
2.6.2	Flushing the Cache	2-17
2.6.3	Displaying Cache Counters	2-17
2.7	Managing the Data Cache	2-18
2.7.1	Specifying the Size of the Cache	2-18
2.7.2	Specifying the Per-File Quota	2-19
2.7.3	Displaying Cache Counters	2-19
2.8	Using a Cluster as a DECdfs Server	2-20
2.8.1	Serving an Access Point from a Cluster Alias	2-20
2.8.2	Serving an Access Point from Individual Cluster Members	2-21
2.9	Stopping and Starting DECdfs on Your System	2-21

3 Managing a DECdfs Client

3.1	Setting System Parameters	3-1
3.2	Mounting Access Points	3-2
3.2.1	Assigning Device Unit Numbers	3-2
3.2.2	Assigning Logical Names	3-2
3.2.3	Specifying Volume Names	3-2
3.2.4	Enabling Data Checking	3-3
3.2.5	Mounting Alternative Access Points	3-3
3.3	Displaying Client Device Information	3-3
3.4	Using the Client Device	3-4
3.4.1	Printing Server-Based Files on a Client	3-5
3.4.2	User Identification Codes on Server Files	3-5
3.4.3	Access Control Lists on Server Files	3-5
3.4.4	DECdfs Error Conditions	3-6
3.4.5	DECdfs Mount Verification	3-7
3.4.6	Partially Mounted Devices	3-8
3.5	Performing Checksum Comparisons on DECdfs Connections	3-8
3.6	Printing Files from a Client Device	3-9
3.7	Using the OpenVMS Backup Utility with a Client Device	3-9
3.8	Using a Cluster as a DECdfs Client	3-9
3.8.1	Using Cluster Aliases	3-9
3.8.2	Submitting Print and Batch Jobs	3-10
3.9	Stopping and Starting DECdfs on Your System	3-10

4 DFSS\$CONTROL Commands

ADD ACCESS_POINT	4-3
DISMOUNT	4-5
EXIT	4-6
HELP	4-7
MOUNT	4-8
REMOVE ACCESS_POINT	4-11
SET COMMUNICATION	4-12
SET SERVER	4-15

SHOW ACCESS_POINT	4-17
SHOW CLIENT	4-20
SHOW COMMUNICATION	4-22
SHOW SERVER	4-25
SHOW VERSIONS	4-29
SHUTDOWN COMMUNICATION	4-30
SNAPSHOT CLIENT	4-31
SNAPSHOT COMMUNICATION	4-32
SNAPSHOT SERVER	4-33
START COMMUNICATION	4-34
START SERVER	4-35
STOP COMMUNICATION	4-36
STOP SERVER	4-37

A Status Messages

B Troubleshooting the DECdfs Environment

B.1	What to Do First	B-1
B.2	Controlling Event and Error Messages	B-2
B.3	Using Other DECdfs Servers and Clients to Isolate Problems	B-3
B.4	Solving Common DECdfs Problems	B-4
B.4.1	DECdfs Fails After Upgrading from an Earlier Version	B-4
B.4.2	Unexpected Error While Opening a File	B-4
B.4.3	Unexpected Error While Accessing an Open File	B-4
B.4.4	Unexpected DECdns Errors when Performing Access Point Operations	B-5
B.4.5	Problems Accessing Server Files	B-5
B.4.5.1	New Client User Cannot Access Server Files	B-5
B.4.5.2	Existing Client User Cannot Access Server Files	B-5
B.4.6	Problems Printing Server Files	B-7
B.4.7	Problems Backing Up Server Files	B-8

C Adjusting DECnet and Client RMS Parameters to Enhance Performance

C.1	Setting DECnet Network Parameters	C-1
C.1.1	Line Receive Buffers/Station Buffers	C-2
C.1.2	Pipeline Quota (DECnet Phase IV Only)	C-3
C.1.3	Maximum Window (DECnet Phase V Only)	C-3
C.1.4	Maximum Links/Transport Connections	C-4
C.2	Setting Client RMS Default Parameters	C-5
C.2.1	Sequential File Access	C-5
C.2.2	Indexed Sequential File or Relative File Access	C-6

D Obsolete Command Qualifiers and Configuration Logicals

E Information for Programmers

F Restrictions on Extended File Specifications Support

F.1	Requirements for Mounting DECdfs Access Points on an ODS-5 Volume	F-1
F.2	XQP Programming Considerations	F-2
F.2.1	File Naming and Format Changes	F-2
F.2.2	Wildcards in File Specifications	F-2
F.2.3	Modified XQP Attributes	F-2

Index

Examples

2-1	Creating a DFSS\$DEFAULT Account	2-4
-----	--	-----

Figures

1-1	DECdfs Client-Server Relationship	1-2
1-2	Interaction Between DECdfs and the DECdns Server	1-4
1-3	Correlation Between a Client Device and an Access Point	1-6
1-4	Server-Client Information Flow	1-8
1-5	Standard OpenVMS File Access Functions	1-10
1-6	DECdfs File Access Functions	1-11
2-1	Access Point at the Master File Directory	2-9
2-2	Access Point at a Subdirectory	2-10
B-1	Event and Error Message Paths	B-3

Tables

1-1	DECdfs Features and Restrictions	1-2
1-2	DFSS\$CONTROL Commands	1-12
1-3	DECdfs System Files	1-13
2-1	Persona Cache Counters	2-17
2-2	Data Cache Counters	2-19
3-1	Client Counters	3-4
3-2	ACL-Related Error Codes	3-6
3-3	Mount Verification Error Codes	3-8
B-1	Error Codes While Opening Files	B-4

Preface

This manual describes DECdfs for OpenVMS management concepts and procedures and the functions of the management commands. It assumes a division of job responsibilities between the person who manages DECdfs on a network node and the person who manages the Digital Distributed Name Service (DECdns) for a network. Such a division of responsibilities may not always exist. If you need information on DECdns, see the manuals entitled *DECdns Management*, <REFERENCE>(DNPLUS_DNS_MGMT), and *DECnet/OSI DECdns Management*.

Intended Audience

This manual is intended for the DECdfs manager: anyone who sets up, controls, and tunes performance of a DECdfs server, client, or both. Managers must have OpenVMS knowledge and experience to the system manager level and access to the OpenVMS documentation set and to the DECnet documentation set.

Users who need information only about DECdfs commands can find it in the command dictionary in Chapter 4. The manual should be useful to these users, but it is not directed toward them.

Associated Documents

The DECdfs for OpenVMS documentation set consists of this manual, the <REFERENCE>(DFS_inst_guide), and the <REFERENCE>(dfs_rel).

Use the OpenVMS documentation set and the appropriate DECnet documentation sets for background and reference information on system management and network management. This manual references the following documents:

- *Guide to OpenVMS File Applications*
- *HP OpenVMS Guide to System Security*
- *OpenVMS User's Manual*
- *HP OpenVMS System Manager's Manual*
- *HP OpenVMS I/O User's Reference Manual*
- *HP OpenVMS System Services Reference Manual*
- *DECnet for OpenVMS Network Management Utilities*
- <REFERENCE>(DNPLUS_NCL_REF)
- *DECnet/OSI Network Control Language Reference*
- *DECnet for OpenVMS Networking Manual*
- *DECdns Management*
- <REFERENCE>(DNPLUS_DNS_MGMT)

- *DECnet/OSI DECdfs Management*

Reader's Comments

Compaq welcomes your comments on this manual.

Print or edit the online form SYSSHELP:OPENVMSDOC_COMMENTS.TXT and send us your comments by:

Internet	openvmsdoc@zko.mts.dec.com
Fax	603 884-0120, Attention: OSSG Documentation, ZKO3-4/U08
Mail	Compaq Computer Corporation OSSG Documentation Group, ZKO3-4/U08 110 Spit Brook Rd. Nashua, NH 03062-2698

How To Order Additional Documentation

Use the following World Wide Web address to order additional documentation:

<http://www.openvms.digital.com:81/>

If you need help deciding which documentation best meets your needs, call 800-DIGITAL (800-344-4825).

Conventions

Special type	This special type in examples indicates system output or user input.
Bold type	Bold type in hardcopy examples indicates user input.
[]	Brackets in command lines indicate that the enclosed values are optional. (Do not type the brackets.)
UPPERCASE	Uppercase letters in command lines indicate keywords that must be entered. You can enter them in either uppercase or lowercase. You can abbreviate command keywords to the minimum unique abbreviation.
lowercase letters	Lowercase letters (often hyphenated) in command syntax or examples indicate variables that the user replaces with appropriate values.

The Return key, which you must press in order to execute commands, is assumed in command examples.

All numbers are decimal unless otherwise noted.

In the DECdfs documentation, DECnet Phase IV is used to refer to DECnet for OpenVMS, and DECnet Phase V is used to refer to either or both DECnet/OSI and DECnet-Plus for OpenVMS.

Throughout this manual, the term *you* refers to the DECdfs manager: a system manager or other person responsible for installing and managing the DECdfs functions on a node. The term *users* refers to both the persons and the applications who access files through a DECdfs client. In addition, information about a system also applies to a cluster, except as noted.

Introduction to DECdfs

DECdfs for OpenVMS client and server software allows users on a local OpenVMS or OpenVMS Cluster system to access files on a remote OpenVMS or OpenVMS Cluster system in a DECnet Phase IV or DECnet Phase V network. DECdfs enables the remote disk to function similarly to a local disk. A client user can set his or her default device and directory to the DECdfs device, edit files there, run programs, or copy files to his or her local device and directory. DECdfs includes the following advantages:

- *Manageability:* Centralizing file resources on one system simplifies management. With DECdfs, you do not have to maintain multiple accounts for multiple users on multiple systems across the network. You can move files without disturbing end-user applications or work patterns, and you can back up all of your data with a single backup operation.
- *Convenience:* Even geographically dispersed users can easily access common files just as they access local files.
- *Timesaving:* DECdfs saves users the time spent copying files from remote nodes over the network.
- *Resource-Use Reduction:* DECdfs uses less CPU time and less disk space and requires less labor for maintenance. You can place commonly used files on a single DECdfs server node and eliminate the redundancy of maintaining several copies on multiple nodes across the network.
- *Security:* You can control user access to server files by using proxy access.

The DECdfs file access protocol works in any DECnet environment but performs especially well with high-speed LAN lines. This speed accounts for ease of access: users can access files on a remote server as quickly as on a local device.

Figure 1-1 illustrates the client-server relationship between two systems running DECdfs. The figure shows the DCL TYPE command at the client system, which displays a file that resides on a disk at the server. Note that the command does not include a node name or access-control information, as would be necessary in an ordinary network operation.

Introduction to DECdfs

Figure 1–1 DECdfs Client-Server Relationship

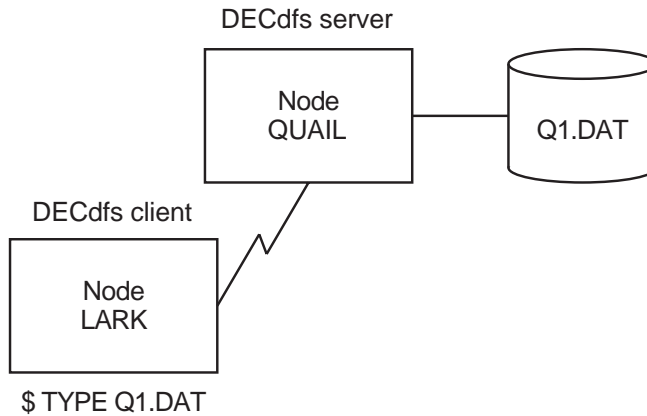

ZK-5421A-GE

DECdfs can play a special role in an environment where many users have systems with limited disk space. If you off-load files that require significant disk space to a single server, you free resources at each client. If you also move files that require frequent backup operations to the server, you lessen the time and cost of multiple backups.

OpenVMS Cluster environments allow multiple systems to share files. Like clusters, DECdfs provides file sharing, but in contrast to clusters, it allows client systems to be autonomous.

When selecting the applications to use with DECdfs, note the features and restrictions listed in Table 1–1.

Table 1–1 DECdfs Features and Restrictions

DECdfs allows users to...	But does not allow them to...
Create and manipulate directories	Perform logical and physical I/O
Share a file for concurrent reading with other users	Share a file when a user is writing to the file
Use all file QIO function codes	Use the shared-write option; DECdfs converts the shared-write option to the exclusive-write option.
Use all Record Management Services (RMS) features or the QIO interface	Install files as known images on the client if the files reside at a disk at the server
Run applications at the client that use mapped sections on the server	Use system page files or swap files on the server

The following scenarios illustrate the usefulness of DECdfs:

- In any environment, a group can keep help files, such as the OpenVMS HELP library, on a single DECdfs server disk. In this way, individual systems avoid storing and maintaining their own help files and instead read the files from a shared disk.
- In a computer-aided design (CAD) laboratory, designers use schematic capture systems that include extensive parts libraries. Each designer has a workstation running OpenVMS and needs access to all the parts in all the libraries. These libraries use large amounts of disk space and require frequent updates. With DECdfs, you can store the parts libraries on one

system in the network. This reduces demands on disk space and facilitates keeping the libraries up to date.

- In a development environment, many programmers share a code management system, such as DEC Code Management System (CMS). Storing the CMS libraries on a DECdfs server allows their considerable disk-space requirements to be centralized where available disks reside. Each developer checks out a particular source file and edits it on his or her own DECdfs client system. When compiling and linking at the client, however, the code compiles and links with the other source and object files, which remain on the server.

The remainder of this chapter describes the basic components of a DECdfs environment and the interface for managing DECdfs.

1.1 Components of a DECdfs Environment

As described in the introduction to this chapter, DECdfs creates a client-server relationship among network nodes. A node can be a client, a server, or both. A client-and-server node can share one of its disks with other nodes while accessing files on another node's disks. This manual refers separately to the client and server functions at such nodes. When the manual refers to a client or a server, it refers to functions that can exist on the same node unless the reference is specifically to a remote client or remote server.

The following sections describe the components of a DECdfs environment.

1.1.1 Digital Distributed Name Service

Like DECdfs, the Digital Distributed Name Service (DECdns) implements a client-server relationship between the user of resources and the provider of resources. As a user of DECdns, each DECdfs node is a DECdns client. The DECdns system that provides information about the location of files is a DECdns server.

DECdns provides a network-wide registry of shareable resources; if available, it maintains an account of the location of file resources that DECdfs servers make available and that DECdfs clients use. DECdns is available on the following systems:

- VAX and Alpha processors running DECnet Phase V
- VAX processors running the OpenVMS operating system

DECdns is not available on OpenVMS Alpha systems unless the system is running DECnet Phase V. If a node does not provide DECdns software, DECdfs cannot access the DECdns registry of available resources. In this case, DECdfs requires users on nodes without DECdns to specify the node name where the resource is located. Using DECdfs on nodes without DECdns is described in Section 2.3.2.2.

If DECdns is available, whenever a DECdfs server makes available a group of files, it notifies the DECdns server. DECdns records the global (networkwide) name of the files and address information needed to communicate with the DECdfs server. To use the DECdfs server, a DECdfs client queries the DECdns server for the DECdfs server's address information. The client then passes the node address to DECnet for setting up a network connection (link) between the DECdfs client node and the DECdfs server node. After the client receives the server address information from DECdns, it communicates directly with the server. Figure 1-2 illustrates how DECdfs interacts with DECdns.

Introduction to DECdfs

1.1 Components of a DECdfs Environment

If a DECdfs client wants to access a resource on a DECdfs server but the client cannot access the DECdns server that has registered the resource, the client must specify the node name of the DECdfs server it wants to use. If a DECdfs server cannot access the DECdns server, *all* DECdfs clients that want to use the DECdfs server's resource must specify that server's node name.

Figure 1-2 Interaction Between DECdfs and the DECdns Server

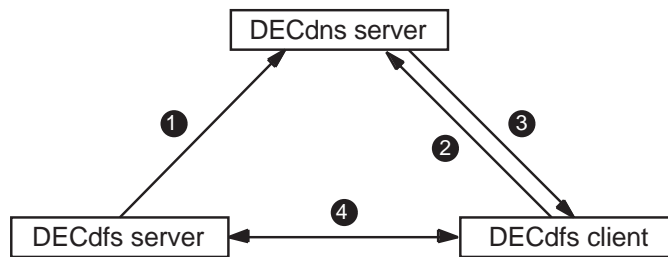

- 1 The DECdfs server notifies DECdns about the available files.
- 2 The DECdfs client queries DECdns for the location of the files.
- 3 DECdns gives the server's network address information to the DECdfs client.
- 4 The DECdfs client and the server communicate directly with each other.

ZK-5422A-GE

DECdns registers information about network resources in a *namespace*, which is the registry of network names managed by DECdns. Certain DFSS\$CONTROL commands listed in Section 1.4 allow you to add and remove information from the DECdns namespace. If you need to move a DECdfs disk from one server to another, you can simply remove and reregister the DECdns information. The users at a client never need to know that the location of the files has changed. Users on nodes that are not running DECdns will need to know of a resource relocation because these users explicitly specify the name of the server where the resource resides.

Consult with the DECdns manager (a person responsible for managing DECdns) at your site before setting up DECdfs on your system. The DECdns manager needs to know how you plan to set up DECdfs, and you need information on how the DECdns manager has set up DECdns. For example, some DFSS\$CONTROL commands require that you specify names that conform to the DECdns naming conventions in your network. A DECdns manager can create a single-directory namespace or a hierarchical namespace. It is important to know which type of namespace your network is using so that you can use the DFSS\$CONTROL commands correctly. The DECdns manager must inform DECdfs users of any access point changes that make access impossible.

1.1.2 Access Points

An *access point* represents the file resources that a server makes available to clients. It allows the server to name the available resources and allows the client to find the resources. An access point refers to a specific directory (usually the master file directory) on a specific device.

At a server, the DECdfs manager decides what directory on what device to make available to DECdfs client users. The access point gives access to that directory and all subdirectories. The master file directory is the default choice. The DECdfs manager gives the access point a name. Using the DFSS\$CONTROL command

Introduction to DECdfs

1.1 Components of a DECdfs Environment

ADD ACCESS_POINT, the manager then registers the access point name with the local DECdfs *server database* (see Section 1.1.3.1) and with DECdns. If DECdns is not available, the access point is recorded only in the server database. See Section 2.3.2.2 for information on adding access points on systems without DECdns.

At a client, the DECdfs manager enters the DFSS\$CONTROL command MOUNT to make that access point available on the system. DFSS\$CONTROL provides a DCL-like interface, and mounting the access point is much like mounting an actual device. The MOUNT command functions as follows:

- Causes the client system to create a DECdfs client (DFSC) device.
The client device (called the DFSC device) is a *pseudodevice*, a forwarding mechanism through which a physical device can be reached. The system treats a pseudodevice as if it were a physical I/O device though it is not (hence the name).
- Creates a correlation between the DFSC device and the server device and directory to which the access point refers.

When a user on a client system first mounts an access point, DECdfs queries DECdns to find out which node serves that access point. Systems not running DECdns must use the /NODE qualifier to specify the DECdfs server name. If a DECdfs connection to the server does not already exist, the client sets up one. If a DECnet logical link does not already exist, the client also requests DECnet to provide one.

The DECdfs Communication Entity creates one connection for all communication between a server and a particular client. This single connection provides DECdfs service to any number of users at the client. The users can mount any number of access points on the server and open any number of files.

End users on the client can then use the mounted client device as if it were a local device. If you assign a logical name to the client device, access to the files can be simple. End users enter standard DCL file commands requesting directories of, or access to, files on the client device. DECdfs intervenes and interacts with DECnet software to redirect these requests across the network to the server of the actual device.

Figure 1–3 illustrates the correlation between a client device and access point named HELP.

Introduction to DECdfs

1.1 Components of a DECdfs Environment

Figure 1-3 Correlation Between a Client Device and an Access Point

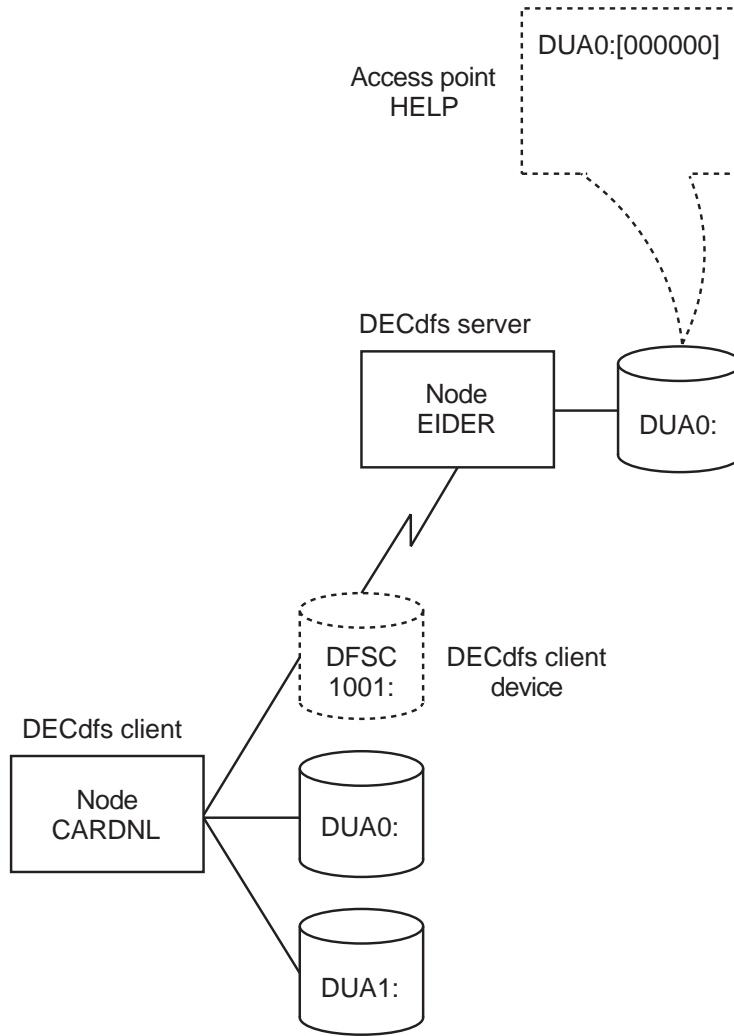

ZK-5423A-GE

In Figure 1-3, a correlation exists between client device DFSC1001: on node CARDNL and the access point that refers to DUA0:[000000] on node EIDER. A user at CARDNL can access files subordinate to DUA0:[000000] by specifying the device DFSC1001: with the file specification in DCL commands. If the DFSC1001: client device has the logical name HELP_LIBRARY, as in the previous example, the user can specify HELP_LIBRARY in the file specification.

1.1.3 DECdfs Management Components

DECdfs is comprised of three cooperating management components: the server, the client, and the Communication Entity. Each has a name, attributes describing it, and an interface supporting management operations. Sections 1.1.3.1, 1.1.3.2, and 1.1.3.3 describe the function of each component.

1.1.3.1 The Server

The *server* implements the server function on a node, as follows:

- Adds and removes access points
- Interacts with the OpenVMS operating system to verify user access rights and manipulate files

The server also contains the *server database*, which is the local registry of resources. Information in the server database usually matches information in DECdns namespace, if DECdns is available. Occasionally, however, the server database and DECdns information may differ (see Section 2.3.6).

The server is implemented by the following files:

- DFSSSERVER_ACP.EXE, the server's ancillary control process (ACP). The server process name is DFSS00010001_1.
- DFSSDRIVER.EXE, the server driver

The installation procedure places these files respectively in the SYSS\$SYSTEM and SYSS\$LOADABLE_IMAGES directories.

To manage a DECdfs server, you must prepare the system for the expected amount of use. You can display and set various parameters of the server to improve performance and control use. Chapter 2 describes the management tasks for servers.

1.1.3.2 The Client

The *client* implements the client function on a node. Each DFSC device represents the client, which resides in the DFSC device driver. The client functions as follows:

- Receives I/O sent to the client device and forwards it to the remote server, through the Communication Entity and the network.
- Receives I/O from the remote server and forwards it to the end user.

The client is implemented by the SYSS\$LOADABLE_IMAGES:DFSCDRIVER.EXE file, which is the DECdfs client device driver.

Chapter 3 describes the management tasks for a client.

1.1.3.3 The Communication Entity

The *Communication Entity* passes information between the server or client and the network software. The Communication Entity is automatically part of any DECdfs installation, whether the node is a client only or both a client and a server. Without the Communication Entity, the client and server would not be able to communicate across the network.

Client requests to servers and server responses to clients pass through the Communication Entity to acquire network services. The Communication Entity functions as follows:

- Creates DECdfs connections
- Controls the flow of data
- Interacts with the DECnet software to open logical links (transport connections)
- Scans for and times out inactive links

Introduction to DECdfs

1.1 Components of a DECdfs Environment

- Checks data integrity by performing checksums (if desired)

Figure 1-4 illustrates the flow of information between client and server as it passes through the Communication Entity and the DECnet software.

Figure 1-4 Server-Client Information Flow

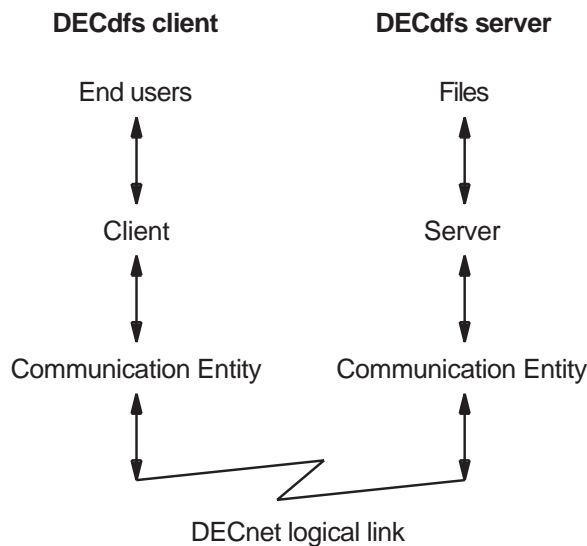

ZK-5424A-GE

A *DECdfs connection* represents a relationship between a DECdfs server and client through the Communication Entity.

The client initiates a connection to a server. The client then uses that connection for all communication to all access points on that server. There can be two DECdfs connections between any two nodes only if each node has both a client and a server and if each node's client is accessing the other node's server. To display the connections on your system, enter the following DFSSCONTROL command:

```
DFS> SHOW COMMUNICATION/CURRENT_CONNECTIONS
```

A DECdfs connection may or may not have an active DECnet link at a single point in time. When a client first mounts an access point, the Communication Entity requests a logical link from DECnet. All communication between the client and server passes through that link. When the Communication Entity finds that the link was not used during a specified timeout period, it disconnects the link, giving resources back to the server. However, DECdfs stores the server's network address information and maintains the DECdfs connection. The Communication Entity provides links for that connection as needed and times them out as appropriate, until the client device is dismantled.

Occasionally, DECdfs creates a connection between a client and server in another way. The DFSSCONTROL command SHOW ACCESS_POINT/FULL displays access point names (from DECdns) and status (from server databases). Entering this command causes DECdfs to create a connection between your node and each node from which you display server database information. Some commands, such as ADD ACCESS_POINT and REMOVE ACCESS_POINT, create DECdfs connections to the local server. You might see such connections when you display the connections on your system.

The following files implement the Communication Entity:

- DFSS\$COM_ACP.EXE, the communication ACP
- DFSRRDRIVER.EXE, the communication driver

The installation procedure places these files respectively in the SYSS\$SYSTEM and SYSS\$LOADABLE_IMAGES directories.

1.2 Client-Server Consistency Issues

This section contains information on system times and logical names on the client and server. See Section 2.2.2.3 for information about consistency of user names on the client and server.

1.2.1 System Times on the Client and Server

DECdfs does not coordinate the system times on the client and server. Some applications, such as the DEC Code Management System (CMS), need consistent timestamps to work correctly; therefore, you must coordinate the system times of clients and servers interactively.

Note

If the client and server are in the same time zone, a network time synchronization service can help eliminate problems caused by inconsistent system times. If the client and the server are not in the same time zone, you should set the time on both to Greenwich Mean Time, to avoid time problems caused by geographical differences.

DECdfs treats timestamps differently within files and in file headers. Timestamps recorded in records within files are based on the client system time. Timestamps recorded in file headers (and displayed with the DIRECTORY/DATE or DIRECTORY/FULL command) are usually based on the server system time. Exceptions do exist. For example, if you use the COPY command without specifying an output file name, the command sets the output file's creation date equal to the input file's creation date. The file's timestamp is whatever system time the input file originally had.

1.2.2 Logical Names on the Client and Server

Logical names are valid only on the local system. The client system does not have information about logical names defined on the server. If a user needs to use a logical name to access files on the server, you need to define that logical name on the client system. For example, if you use DECdfs to access a CMS library that users specify with a logical name, define the logical name on the client system to represent the library.

1.3 Comparison of Standard OpenVMS File Access and DECdfs File Access

DECdfs divides standard OpenVMS file access functions between two cooperating nodes.

Figure 1-5 illustrates the standard OpenVMS file access functions and shows where DECdfs divides the file access functions between the client and server. In the figure, an application requests access to a file by entering either a Record Management Services (RMS) call or a QIO directly to the disk driver. The

Introduction to DECdfs

1.3 Comparison of Standard OpenVMS File Access and DECdfs File Access

Files-11 extended \$QIO system service processor (XQP) opens and accesses the file through the disk driver.

Figure 1-5 Standard OpenVMS File Access Functions

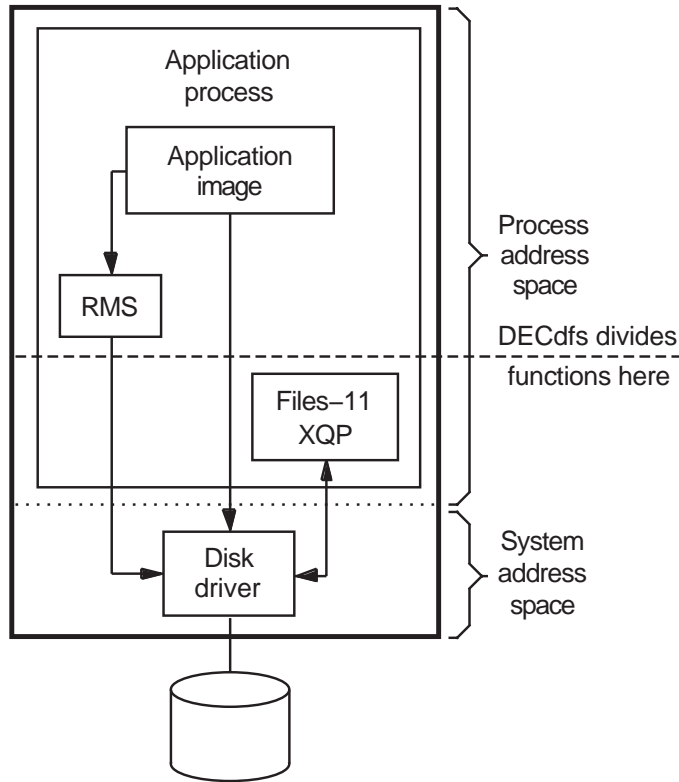

ZK-5425A-GE

Note

The direction of the arrows in Figure 1-5 indicates the flow of control (not the flow of information, which exists in both directions).

Figure 1-6 shows the same file access functions as those in Figure 1-5 and illustrates how DECdfs divides the functions between the client and server nodes. The application and RMS remain on the client. To reach the disk driver and the Files-11 XQP, however, the application's request passes through the DECdfs drivers and over the network.

1.3 Comparison of Standard OpenVMS File Access and DECdfs File Access

Figure 1–6 DECdfs File Access Functions

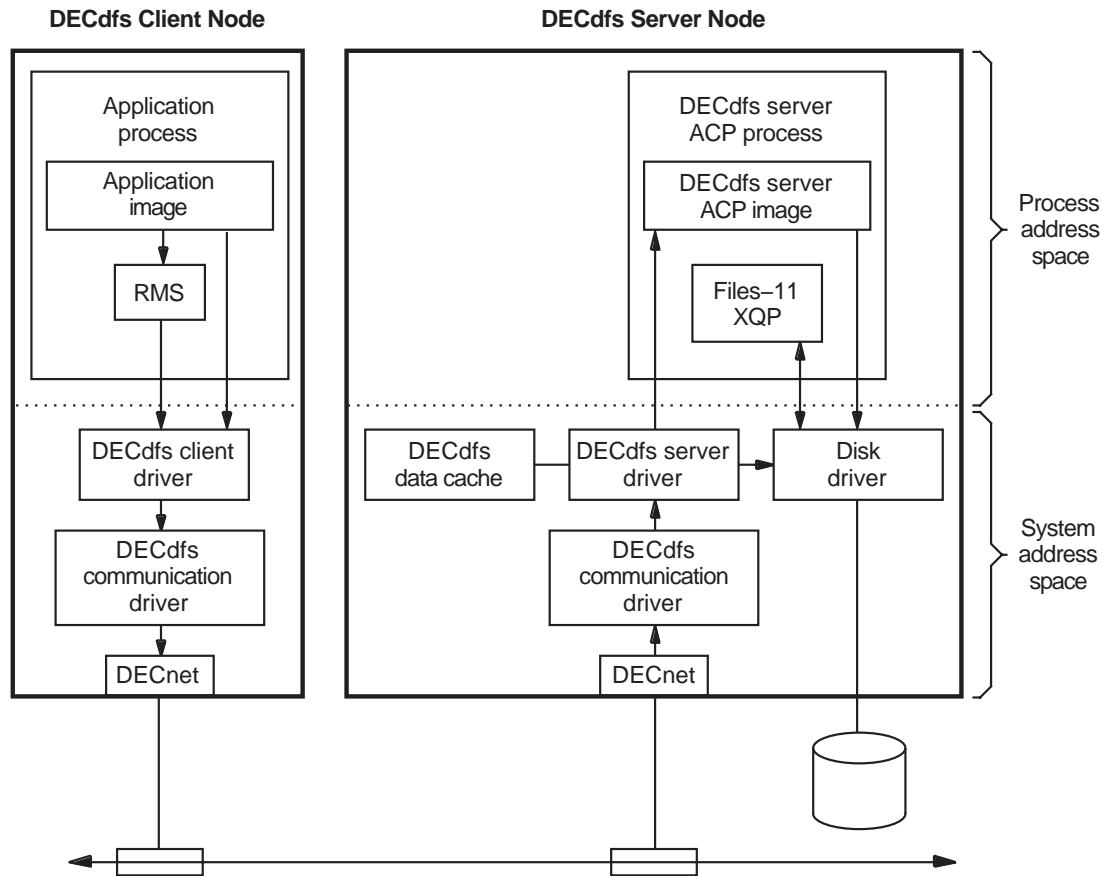

ZK-5426A-GE

Figure 1–6 shows the following activity at the client:

- The application sends a request to access a device, either through RMS or by using direct QIO functions. Both access the device driver.
- Because the request is sent to a DECdfs client device, the request goes to the DECdfs client driver instead of a standard local disk driver. The DECdfs client driver passes the request to the DECdfs Communication Entity driver.
- The Communication Entity forwards the request to DECnet software for transmission over the network.

Figure 1–6 shows the following activity at the server:

- DECnet software receives the request and passes it to the DECdfs Communication Entity driver.
- The communication driver passes the request to the DECdfs server driver.
- If the request is a read or write request to an open file, the server driver accesses the disk driver directly.

Introduction to DECdfs

1.3 Comparison of Standard OpenVMS File Access and DECdfs File Access

- If the request is an XQP function, such as a request to open, close, or search a directory for a file, the server driver passes it to the DECdfs server ancillary control process (ACP).

The server ACP interacts with OpenVMS to validate the user and to access the file.
The server ACP then passes the request to the disk driver and to the Files-11 XQP for continued file I/O.
- To expedite any repeated use of file blocks and to avoid needless disk access, the DECdfs server uses a file data cache. Section 2.7 explains this cache in further detail.

1.4 The DFSS\$CONTROL Commands

DFSS\$CONTROL is a set of commands that you use to manage DECdfs. The commands allow you to set up, monitor, tune, and customize your DECdfs environment, particularly on a server. However, most parameters to the DECdfs software have default values that should provide a satisfactory balance between economical use of resources and good performance. Generally you need only use DFSS\$CONTROL to start the DECdfs client, server, and Communication Entity and to add access points on a server or mount them on a client.

Table 1–2 lists the DFSS\$CONTROL commands.

Table 1–2 DFSS\$CONTROL Commands

Command	Description
Entered at Either a Server or Client	
EXIT	Terminates the DFSS\$CONTROL session.
HELP	Displays information on DFSS\$CONTROL commands.
SET COMMUNICATION	Sets parameters for the DECdfs Communication Entity.
SHOW ACCESS_POINT	Displays the names of access points stored by DECdfs.
SHOW COMMUNICATION	Displays information about the DECdfs Communication Entity.
SHOW VERSIONS	Displays version information for DECdfs components.
SHUTDOWN COMMUNICATION	Stops DECdfs communication after completing file operations in progress.
SNAPSHOT COMMUNICATION	Records the current communication counters in DFSS\$CONTROL memory or in a specified file.
START COMMUNICATION	Starts the Communication Entity.
STOP COMMUNICATION	Stops DECdfs communication immediately.

(continued on next page)

Table 1–2 (Cont.) DFSS\$CONTROL Commands

Command	Description
Entered at a Server Only	
ADD ACCESS_POINT	Makes an access point available by registering it in the server database and with DECdns.
REMOVE ACCESS_POINT	Removes an access point name from the server database and from DECdns.
SET SERVER	Sets parameters for the DECdfs server.
SHOW SERVER	Displays information about the DECdfs server.
SNAPSHOT SERVER	Records the current server counters in DFSS\$CONTROL memory or in a specified file.
START SERVER	Starts the DECdfs server.
STOP SERVER	Stops the DECdfs server.
Entered at a Client Only	
DISMOUNT	Makes a DECdfs client device (and therefore an access point) unavailable to users.
MOUNT	Mounts an access point as a DECdfs client device.
SHOW CLIENT	Displays information about a DECdfs client device.
SNAPSHOT CLIENT	Records the current client counters in DFSS\$CONTROL memory or in a specified file.

See Chapter 4 for a dictionary of DFSS\$CONTROL commands.

1.4.1 Using DFSS\$CONTROL Commands in DECdfs Command Files

For routine operation, DECdfs command files execute the basic DFSS\$CONTROL commands that set up your DECdfs environment. The <REFERENCE>(DFS_inst_guide) describes the startup and configuration files that you edit and execute. These files are located in the SYSS\$MANAGER and SYSS\$STARTUP directory. Table 1–3 summarizes these files.

Table 1–3 DECdfs System Files

File	Comment
DFSS\$STARTUP.COM	Do not edit this file, but note that it executes DFSS\$CONFIG and DFSS\$SYSTARTUP, both of which you may edit.
DFSS\$CONFIG.COM	This file contains the SET commands that set parameters for the DECdfs server and Communication Entity. DFSS\$STARTUP executes this file before it starts the DECdfs processes. The commands have default values, so edit this file only if you want to change the parameter values.

(continued on next page)

Introduction to DECdfs

1.4 The DFS\$CONTROL Commands

Table 1–3 (Cont.) DECdfs System Files

File	Comment
DFSS\$SYSTARTUP.COM	This file contains commands that add access points at a server and mount access points at a client. On a server, keep this file up to date to add the access points each time DECdfs starts up. On a client, use this command file to mount access points for systemwide use.
OpenVMS VAX Version 5.5-2	
SYSTARTUP_V5.COM	Edit the system SYSTARTUP_V5 file so that it executes the SYSS\$STARTUP:DFSS\$STARTUP command file. DECnet startup must complete before DECdfs startup begins. SYSTARTUP_V5.COM is in the SYSS\$MANAGER directory.
OpenVMS VAX Version 6.n OpenVMS Alpha Version 6.n OpenVMS Alpha Version 7.n	
SYSTARTUP_VMS.COM	Edit the system SYSTARTUP_VMS.COM file so that it executes the SYSS\$STARTUP:DFSS\$STARTUP command file. DECnet startup must complete before DECdfs startup begins. SYSTARTUP_VMS.COM is in the SYSS\$MANAGER directory.

1.4.2 Using DFS\$CONTROL Commands Interactively

Some DFS\$CONTROL commands, such as the SHOW commands, are appropriate only for interactive use. You can enter DFS\$CONTROL commands at the OpenVMS system prompt in one of the following ways:

- Preface the command with the string DFSCP as shown in the following example:

```
$ DFSCP ::= $DFS$CONTROL
$ DFSCP SHOW VERSIONS
```

- Invoke the DFS\$CONTROL program, invoke the DFS prompt, and enter commands as shown in the following example:

```
$ RUN SYS$SYSTEM:DFS$CONTROL
DFS> SHOW VERSIONS
```

You can use other commands either interactively or by executing the DFS\$CONFIG or DFSS\$SYSTARTUP command files. If you choose to interactively enter a command that one of these files usually executes, edit the file to reflect any new values that you have set. This ensures that, for DFS\$CONFIG, the next startup uses the most recent value or, for DFSS\$SYSTARTUP, your system adds or mounts all access points.

1.4.3 Getting Help with DECdfs

The DFS\$CONTROL HELP command displays a list of topics on which you can obtain information. Entering HELP and a command name displays information on the specified command.

Brief DECdfs help is also available at the DCL prompt:

```
$ HELP DFS
```

Managing a DECdfs Server

Managing a DECdfs for OpenVMS server involves first preparing the system for use by DECdfs and then using DFS\$CONTROL commands to create one or more access points and make them available. If you choose, you can also use DFS\$CONTROL commands to tailor the operation of the server and the Communication Entity to enhance performance.

This chapter describes the following management tasks:

- Setting system parameters
- Setting up proxy accounts
- Creating and managing access points
- Protecting server files
- Protecting individual files
- Managing the persona cache
- Managing the data cache
- Using a cluster as a DECdfs server
- Stopping and starting DECdfs on your system

Most of these tasks involve the use of DFS\$CONTROL commands and qualifiers. For complete information on a command, see Chapter 4.

After you read this chapter, set the necessary system and network parameters and edit the DFS\$CONFIG.COM and DFS\$SYSTARTUP.COM files. You can then start DECdfs on your system by executing the SYS\$STARTUP:DFS\$STARTUP.COM file.

2.1 Setting System Parameters

Running DECdfs on an OpenVMS system requires that you adjust certain system generation (SYSGEN) parameters. Before installation, change the CHANNELCNT, NPAGEDYN, GBLPAGES, GLBSECTIONS, and INTSTKPAGES (VAX only) parameters as directed in the <REFERENCE>(DFS_inst_guide). On OpenVMS VAX systems, increasing the INTSTKPAGES parameter is especially important. If the number of interrupt stack pages is not large enough, an interrupt stack overflow can cause your system to halt.

Sections 2.1.1, 2.1.2, and 2.1.3 describe DECdfs Communication Entity and server parameters that work with each other and with system and network parameters. These sections describe the parameters that limit the number of open files and the amount of DECdfs activity.

Managing a DECdfs Server

2.1 Setting System Parameters

The parameters work together in a layered manner; that is, you can set parameters at the system level, network level, or application DECdfs level. Setting a low value at any one of those levels affects the server's operation, even if you set higher values at the other levels. For example, if you specify that the DECnet network should establish very few logical links to and from your system, the low number of links prevents DECdfs from establishing a high number of connections.

For information about limiting logical links at the network level, see Appendix C.

2.1.1 Limiting the Number of Open Files

Your system's channel count parameter, CHANNELCNT, specifies the maximum number of files that any process on the system can open concurrently. Each file requires one channel, and the DECdfs server process opens all local files that users at DECdfs clients access. If the server is your system's most active file user, you may need to increase the channel count to accommodate the server.

Determine the appropriate CHANNELCNT parameter by estimating the maximum number of simultaneously open files you expect on the server. Add 15 to this number to allow for some additional channels for the server's own use. For example, if you expect 250 files to be open simultaneously, set the CHANNELCNT parameter to 265 channels before running DECdfs. To show the current value for the CHANNELCNT parameter, invoke SYSGEN as follows:

```
$ RUN SYS$SYSTEM:SYSGEN
SYSGEN> USE CURRENT
SYSGEN> SHOW CHANNELCNT
```

SYSGEN displays the settings for CHANNELCNT under the Current heading, as follows:

Parameter Name	Current	Default	Minimum	Maximum	Units	Dynamic
CHANNELCNT	202	127	31	2047	Channels	

Insert the following line in the MODPARAMS.DAT file in the SYS\$SYSTEM directory, and then run the AUTOGEN procedure:

```
MIN_CHANNELCNT = 265
```

For information on AUTOGEN, see the *HP OpenVMS System Management Utilities Reference Manual*. You can read the online help information about the CHANNELCNT parameter by entering the following SYSGEN HELP command:

```
$ RUN SYS$SYSTEM:SYSGEN
SYSGEN> HELP PARAMETERS SPECIAL_PARAMS CHANNELCNT
```

2.1.2 Controlling DECdfs Activity

You can control DECdfs activity by specifying the number of outstanding Communication Entity requests allowed by DECdfs. The Communication Entity allows you to specify the number of file I/O requests from clients that can be outstanding at the server simultaneously. To specify this value, enter the DFS\$CONTROL command:

```
DFS> SET COMMUNICATION/REQUESTS_OUTSTANDING_MAXIMUM=value
```

If the number of requests arriving from client systems exceeds the Communication Entity's permitted number of outstanding requests, the Communication Entity stops accepting data from DECnet. The DECnet network layer buffers the requests until the requests reach the value specified by one of these parameters:

DECnet Phase IV: PIPELINE QUOTA parameter

DECnet Phase V: MAXIMUM WINDOW parameter

For more information on these parameters, see Appendix C.

When the limit is reached, DECnet's flow control mechanism stops the client from sending data and returns an error message.

2.1.3 Limiting Inactive DECdfs DECnet Links

The DECdfs Communication Entity monitors the DECnet links, using the time interval specified by the SET COMMUNICATION/SCAN_TIME command. If the Communication Entity finds that a link is inactive on two successive scans, it disconnects the link. The link is reestablished when a user on that client next requests a file operation. The Communication Entity maintains the DECdfs connection even after it times out a link.

2.2 Setting Up Proxy Accounts

Client users must have OpenVMS proxy accounts in order to access the server. You use the Authorize Utility (AUTHORIZE) to create these accounts. The Authorize Utility modifies the network user authorization file, NETPROXY.DAT, so that users at DECdfs clients get the necessary rights and privileges at the server. For information on AUTHORIZE commands, see the *HP OpenVMS System Management Utilities Reference Manual*.

Each remote user can be granted DECnet proxy access to multiple accounts. One of the accounts can be the default proxy account for that user. The DECdfs server recognizes only default proxy accounts.

The following example shows how you use AUTHORIZE to grant proxy access. This example gives user CHRIS on node EGRET access to the existing local account STAFF on the server.

```
$ SET DEFAULT SYS$SYSTEM
$ RUN AUTHORIZE
UAF> ADD/PROXY EGRET::CHRIS STAFF /DEFAULT
UAF> EXIT
```

To give users access to the DECdfs server without giving them explicit proxy accounts, create a default DECdfs account (DFSS\$DEFAULT).

Example 2-1 shows how to set up a default DECdfs account or proxy account that cannot be used for any other purpose except DECdfs access. If your system has a default DECnet account, you can choose the same UIC or the same group code for your DECdfs default account. Using UIC of the DECnet default account allows the DECdfs default account to access those files and directories on the system that are accessible by the DECnet default account. Otherwise, choose a UIC or group code that is different from all other accounts on the system.

Managing a DECdfs Server

2.2 Setting Up Proxy Accounts

Example 2–1 Creating a DFS\$DEFAULT Account

```
$ SET DEFAULT SYS$SYSTEM
$ RUN AUTHORIZE
UAF> ADD DFS$DEFAULT -
/NOACCESS=(PRIMARY, SECONDARY) -
/ASTLM=0 -
/BIOLM=0 -
/BYTLM=0 -
/CLI=no_such_cli -
/CLITABLES=no_such_tbl -
/CPUTIME=:::01 -
/DEFPRIVILEGES=NOALL -
/DEVICE=NLA0: -
/DIOLM=0 -
/DIRECTORY=[no_such_directory] -
/ENQLM=0 -
/FILLM=0 -

/FLAGS=(CAPTIVE, DEFCLI, DISCTLY, DISMAIL, DISNEWMAIL, DISRECONNECT, -
DISWELCOME, LOCKPWD, PWD_EXPIRED, PWD2_EXPIRED, RESTRICTED) -
/GENERATE_PASSWORD=BOTH -
/JTQUOTA=0 -
/LGICMD=no_such_file -
/OWNER="Distributed File Service" -
/PGFLQUOTA=0 -
/PRCLM=0 -
/PRIORITY=0 -
/PRIVILEGES=NOALL -
/PWDEXPIRED -
/PWDLIFETIME=:::01 -
/PWDMINIMUM=31 -
/TQELM=0 -
/UIC=[ggg,mmm] -
/WSDEFAULT=0 -
/WSEXTENT=0 -
/WSQUOTA=0
UAF> EXIT
$
```

The example illustrates creating a well-protected default DECdfs account that is fully usable by DECdfs. See the *HP OpenVMS Guide to System Security* for information on default network accounts. Use care in setting up the account to ensure that DECdfs users have the rights and privileges necessary to access the files they need. If you create a DFS\$DEFAULT account, all users without explicit proxy accounts have the rights, privileges, and identity of DFS\$DEFAULT.

The DFS\$DEFAULT account in Example 2–1 can also serve as a model for an individual proxy account that gives DECdfs users access to the server while preventing other types of access. For detailed information about creating proxy accounts, see the *HP OpenVMS Guide to System Security*, the *DECnet for OpenVMS Network Management Utilities* manual, and the <REFERENCE>(DNPLUS_OVMS_NET_MGMT) manual.

2.2.1 Setting Up Privileges

The privileges that affect file-access checking (BYPASS, GRPPRV, READALL, and SYSPRV) also control DECdfs access to files.

If the proxy account or DFS\$DEFAULT account has any of these privileges as default privileges, the DECdfs server uses them to allow access to files.

If the proxy account or DFS\$DEFAULT account has any of these privileges as authorized privileges, the DECdfs server uses them whenever it detects that the client process has these privileges enabled.

Note

Dynamic enabling and disabling of privileges differs from ordinary DECnet file-access checking, which can use only the default privileges of the proxy or default account.

Allowing SETPRV as an authorized privilege for a DECdfs proxy account or the DFS\$DEFAULT account is the same as allowing all privileges as authorized privileges.

2.2.2 Setting Up UICs, ACLs, and User Names

In some circumstances, the difference between the server environment and the client environment can become obvious to users. This section explains how user identification codes (UICs), access control lists (ACLs), and user names can cause operational discrepancies between the server and client.

2.2.2.1 User Identification Codes

The OpenVMS system on the server interprets a file's user identification code (UIC) according to its rights database (RIGHTSLIST.DAT). The OpenVMS system stores a file owner's UIC as a binary value, which it translates to ASCII according to the rights database when displaying the UIC to a user. When a user at a DECdfs client requests the UIC of a file, the server system passes the binary value to the client system.

If the file UIC and proxy account UIC are the same, DECdfs converts the file UIC to the client account UIC. Otherwise, when the client system translates the binary UIC according to the client system's rights database, the translation might seem incorrect to users at the client system.

Users might have difficulty performing some directory or backup operations on files or directories that are not owned by this particular proxy account on the server. You can eliminate these problems by creating proxy account UICs to match the client UICs. If that is not possible, inform the client system manager or users that UIC discrepancies affect the following DCL commands:

- BACKUP
- DIRECTORY, with the /OWNER, /FULL, or /SECURITY qualifier
- SET FILE, with the /OWNER_UIC qualifier

Managing a DECdfs Server

2.2 Setting Up Proxy Accounts

Note

Client users can avoid problems with the BACKUP command by using the /BY_OWNER=PARENT or /BY_OWNER=ORIGINAL qualifier as described in Section 3.4.2.

For more information about UICs, see Section 3.4.2.

2.2.2.2 Access Control Lists

The OpenVMS system on the server also interprets a file's access control lists (ACLs) according to its rights database. It propagates default access control entries (ACEs) for DECdfs users' files from the directory in which it creates those files. The OpenVMS system enforces ACEs on files at the server; you can log in to the server and set ACEs that control DECdfs access to files. However, users cannot set or display ACLs from a DECdfs client. For more information on ACLs and ACEs, see Section 2.5.

2.2.2.3 User Names

With applications that require user names, a discrepancy can occur if a user has different user names on the client and the server. If the user sometimes accesses the application from a DECdfs client and, at other times, locally from the server, certain operations of the application can fail.

For example, DEC Code Management System (CMS) reserves and replaces software components according to user name. When a user reserves and removes a component, CMS stores that person's user name in its library data file. When the user attempts to replace the component, CMS compares the current user name with the stored name. If the names do not match, the user cannot replace the component. Suppose the CMS libraries are on a server, and a user reserves a library component when running CMS at a client. If the user later logs in to the server and tries to replace the component, CMS rejects the replacement operation unless the user names match.

2.2.3 Giving Cluster Clients Access to Server Files

If the client node is a cluster system, enable the cluster alias outgoing on the client node (see Section 3.8) and add a proxy on the server from the cluster's user to the local user account. This allows users to access DECdfs files regardless of which cluster member they log in to.

To add this proxy, use the following command format at the Authorize Utility's UAF> prompt:

```
UAF> ADD/PROXY client-cluster-name::remote-user user-name /DEFAULT
```

If the client node is a cluster system and the cluster alias outgoing is not enabled, you need to add a proxy on the server from each node in the client cluster to the local user account. This allows users to access DECdfs files regardless of which cluster member they log in to. The following example adds proxies for three nodes residing in a cluster in which the cluster alias is not enabled:

```
UAF> ADD/PROXY NODE_A::B_WILLIAMS B_WILLIAMS /DEFAULT
UAF> ADD/PROXY NODE_B::B_WILLIAMS B_WILLIAMS /DEFAULT
UAF> ADD/PROXY NODE_C::B_WILLIAMS B_WILLIAMS /DEFAULT
```

2.2.4 Allowing Client Users to Print Server Files

To allow client users to print files from your server, you must create special proxy accounts. The OpenVMS print symbiont runs under the SYSTEM account. The client SYSTEM account therefore needs proxy access to your server in order to print files for users.

Giving another node's SYSTEM account proxy access to your node is an issue to resolve according to the security needs at your site.

If the client node is a single-user workstation, you could grant its SYSTEM account access to its user's proxy account on the server. To do so, use the following command format at the Authorize Utility's UAF> prompt:

```
UAF> ADD/PROXY client-node-name::SYSTEM user-name /DEFAULT
```

For example, if Julie's workstation is EAGLE, you can enable her to print DECdfs files by giving the SYSTEM account on EAGLE access to the JULIE proxy account on your server:

```
UAF> ADD/PROXY EAGLE::SYSTEM JULIE
```

If the client node is a time-sharing system with more than one user, however, granting its SYSTEM account access to a nondefault proxy account can pose security risks for files served by DECdfs. Instead, do the following:

1. Use the Authorize Utility to create a special proxy account for client printing. You can name this account DFSS\$PRINT.
2. Set up the account to resemble the DFSS\$DEFAULT account shown in Example 2-1, but replace the /DEFPRIV=NOALL qualifier with /DEFPRIV=READALL and use a different password for the /PASSWORD qualifier.
3. After creating the DFSS\$PRINT account, give the client time-sharing node's SYSTEM account proxy access to it.

However, this method might have a security weakness because it lets the system account at the client read any DECdfs-served file on the server.

Another method for allowing client users to print files on the server is to permit the client SYSTEM account to access DFSS\$DEFAULT. This method is more secure than creating a DFSS\$PRINT account, but it limits users on the client to the following operations:

- Printing files that have the WORLD READ protection setting
- Using the PRINT/DELETE command for files that have the WORLD DELETE protection setting

Note

If the client is a time-sharing system or a cluster, see Section 3.6 for information about using the /DEVICE qualifier with the DFSS\$CONTROL command MOUNT.

A method that Compaq does not recommend, but that you may choose to implement under certain circumstances, is to give the client node's SYSTEM account access to the SYSTEM account on your node. You might do so, for example, if you are the system manager of both the client and the server. To choose this option, use the following command at the UAF> prompt:

Managing a DECdfs Server

2.2 Setting Up Proxy Accounts

```
UAF> ADD/PROXY client-node-name::SYSTEM SYSTEM /DEFAULT
```

Warning

In a large network, using a wildcard to give multiple SYSTEM accounts (*::SYSTEM) access to any nondefault account on your system can be a serious breach of your system's security. This is especially true of giving such access to your SYSTEM account.

2.3 Creating and Managing Access Points

An access point consists of the file resources that a DECdfs server provides to one or more users of a DECdfs client. See Section 1.1.2 for more information about access points. This section discusses the following access point management tasks:

- Deciding where to place access points
- Adding access points
- Changing access points
- Maintaining consistency between the server and DECdns

2.3.1 Deciding Where to Place Access Points

Each time you add an access point on a DECdfs server, you specify a device and directory to which the access point name refers. The DFSSCONTROL command ADD ACCESS_POINT requires a device name and gives you the option of supplying a directory. The default directory is the master file directory for the device ([000000]), but you can place the access point lower in the directory tree. This placement affects the user's perception of the directory structure.

If you place the access point at the device's actual master file directory, end users can access files in the disk's directories as they normally would. Figure 2-1 illustrates this placement, with the access point at the master file directory. The user enters a command that accesses one of the first subdirectories.

Managing a DECdfs Server

2.3 Creating and Managing Access Points

Figure 2-1 Access Point at the Master File Directory

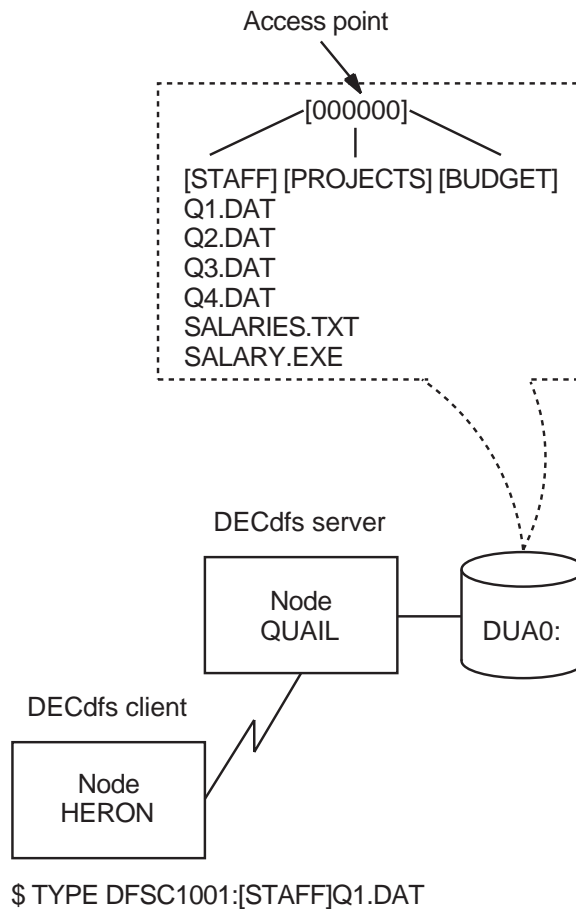

ZK-5427A-GE

If you place the access point at a subdirectory of the master file directory, that subdirectory appears on the client device as a master file directory. To perform file operations in that directory, end users would have to specify the directory as [000000] in their file specifications. Figure 2-2 illustrates this access point placement.

Managing a DECdfs Server

2.3 Creating and Managing Access Points

Figure 2–2 Access Point at a Subdirectory

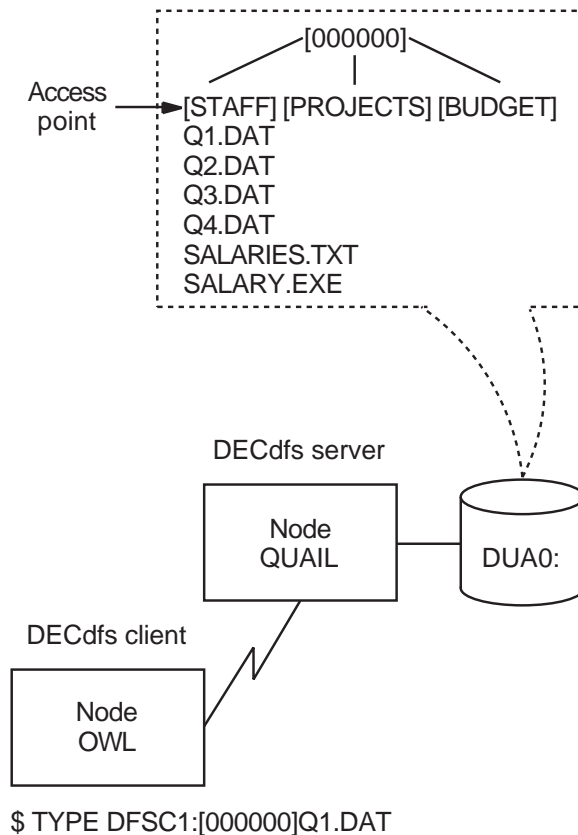

ZK-5428A-GE

The figure shows that [000000] is the actual master file directory for the disk, as viewed from the server. The user command, however, uses [000000] to represent the master file directory for the client device, which is the server directory at which you placed the access point.

The user at a DECdfs client can create subdirectories to the usual OpenVMS depth limit of 8, starting with the master file directory of the client device. If the master file directory on the client device is a subdirectory at the server, the user can create subdirectories that are hidden from OpenVMS at the server. These DECdfs subdirectories can nest as many as eight additional directories at the server. Backing up the server disk includes these DECdfs subdirectories only if you use the /IMAGE or /PHYSICAL qualifier to the BACKUP command. This is similar to what happens when you create rooted-device logical names in OpenVMS (see the *Guide to OpenVMS File Applications*).

2.3.2 Adding Access Points

To add an access point, you use the DFSS\$CONTROL command ADD ACCESS_POINT on the DECdfs server that contains the resource you want to make available. To make the access point available, you enter the DFSS\$CONTROL command MOUNT on a DECdfs client. Refer to Chapter 4 for detailed information on all DFSS\$CONTROL commands.

Managing a DECdfs Server

2.3 Creating and Managing Access Points

The `ADD ACCESS_POINT` command requires that you specify a device and optionally allows you to specify the directory to which the access point refers. When you enter the command, DECdfs adds this information to your node's server database. DECdfs also sends the access point name and your DECnet address information to the Digital Distributed Name Service (DECdns) if this service is available on your system.

Each access point name can contain from 1 to 255 characters. The name can consist of alphanumeric characters and underscores (`_`); a name in a hierarchical DECdns namespace can also contain period (`.`) characters. The dollar sign (`$`) is reserved for use by Compaq Computer Corporation.

It is important to discuss access point names with your DECdns manager before you attempt to create any. Each access point name in a DECdns namespace must be unique, and the names that you create must follow the conventions for your namespace. The organization of the namespace as single-directory or hierarchical also affects the types of names that you create.

A client node typically has one or more remote access points that are mounted automatically during system startup. At the conclusion of DECdfs startup, the startup procedure looks for the file `SYSS$STARTUP:DFSS$SYSTARTUP.COM` and runs it. The file typically contains a series of DFS mount commands to mount the usual access points. If you want to mount access points from clients that are not running DECdns (refer to Section 2.3.2.2), you can edit `DFSS$SYSTARTUP.COM` to include the appropriate `/NODE` qualifiers.

System managers responsible for a number of clients typically maintain a master `DFSS$SYSTARTUP.COM` file which is distributed to the clients each time it is updated.

If you add an access point interactively, it is important to edit the `DFSS$SYSTARTUP` command file. In this way, the server automatically adds the access point the next time that the DECdfs server starts up.

Compaq recommends that you add access points that see an actual directory path, and not a directory alias. For example, on the OpenVMS system disk, the directory `SYSS$SYSDEVICE:[SYS0.SYSCOMMON]` is an alias for the directory `SYSS$SYSDEVICE:[VMS$COMMON]`. Compaq recommends using `SYSS$SYSDEVICE:[VMS$COMMON]` as the access point directory. DECdfs cannot properly derive a full file specification when translating a file identification (FID) whose directory backlinks point to a directory different than the access point directory. If the access point does see a directory alias, incorrect backlink translation affects the `SHOW DEVICE/FILES` and `SHOW QUEUE/FULL` commands.

2.3.2.1 Systems with DECdns

The following list shows the steps for adding and mounting access points on systems running DECdns:

1. The manager at DECdfs server node EIDER adds access point HELP, as follows:

```
DFS> ADD ACCESS_POINT HELP DUA0:[000000]
```

The access point refers to the master file directory ([000000]) of device DUA0:.

Managing a DECdfs Server

2.3 Creating and Managing Access Points

2. The manager at the client then mounts access point HELP, producing a client device with the logical name HELP_LIBRARY. The response to the MOUNT command displays the client device unit number as DFSC1001:.

```
DFS> MOUNT HELP HELP_LIBRARY
%MOUNT-I-MOUNTED, .HELP mounted on _DFSC1001:

DCL commands entered at the client, such as SET DEFAULT and
DIRECTORY, operate on the DECdfs client device as on any other device.

$ SET DEFAULT HELP_LIBRARY:[000000]
$ DIR HELP_LIBRARY:M*.HLB

Directory HELP_LIBRARY:[000000]

MAILHELP.HLB;2          217  29-JUL-1998 14:39:57.50  (RWED,RWED,RWED,RE)
MNRHELP.HLB;2          37   29-JUL-1998 14:41:36.41  (RWED,RWED,RWED,RE)

Total of 2 files, 254 blocks.
$
```

2.3.2.2 Systems Without DECdns

The current version of DECdfs has been modified to operate without using DECdns to accommodate OpenVMS Alpha systems running DECnet. If you have an OpenVMS Alpha system running DECnet Phase V, refer to Section 2.3.2.

A system not running DECdns, such as an Alpha server running DECnet, can be used as a DECdfs server with some limitations. You can declare access points with the DFSSCONTROL command ADD ACCESS_POINT; however, you must include the namespace name in the access point definition. For example:

```
DFS> ADD ACCESS_POINT DEC:.LKG.S.MYDISK DKA300:[000000]
```

This declaration adds the access point locally; that is, the access point is added to the DECdfs server's database but DECdfs does not add the access point to any external name server. However, in systems without DECdns, the MOUNT command in its usual form cannot determine where the specified access point is served. Therefore, the current version of DECdfs supports an additional qualifier to the MOUNT command that identifies the node which serves the access point. The new qualifier is /NODE=node_name and is shown in the following example:

```
DFS> MOUNT DEC:.LKG.S.MYDISK /NODE=SRVR MYDISK
%MOUNT-I-MOUNTED, DEC:.LKG.S.MYDISK mounted on _DFSC1001:
```

You must specify the fully expanded access point name in the MOUNT command. In the previous example, DEC: is the namespace name and .LKG.S.MYDISK is the access point name. The namespace name must be at the beginning and it must be followed by a colon. If it is missing, DECdfs displays the following error message:

```
%DFS-E-NAMSPMSNG, Namespace component of access point is missing
```

If the access point is served by a cluster system, the node name to be specified depends on the cluster configuration and how the access point is added. Refer to Section 2.8 for more information. If the access point is a cluster-wide access point, then the cluster alias can be used for the node name. Otherwise, the name of a specific cluster node, which is known to be serving the access point, must be used.

Managing a DECdfs Server

2.3 Creating and Managing Access Points

When the /NODE qualifier is specified with a MOUNT command, the node name is verified before any action is taken. On a DECnet Phase IV system, an unrecognized node name will produce the following message:

```
%SYSTEM-F-NOSUCHNODE, remote node is unknown
```

On a DECnet Phase V system, the message is:

```
%IPC-E-UNKNOWNENTRY, name does not exist in name space
```

When the /NODE qualifier is specified, DECdfs does not check or expand the access point name even if DECdns is present on the system. The /NODE qualifier must be used to mount an access point on a server that does not have DECdns even if the client does have DECdns.

As stated earlier, the access point name must include the namespace component to be recognized at the server node. If the /NODE qualifier is used and the namespace component is not specified, the logical name DFS\$DEFAULT_NAMESPACE is checked for a namespace prefix to use, for example:

```
$ DEFINE /SYS DFS$DEFAULT_NAMESPACE DEC:
$ DFSCP MOUNT .LKG.S.DFSDEV.VTFOLK_DKA3 /NODE=VTFOLK
```

In this example, DECdfs attempts to mount the access point DEC:.LKG.S.DFSDEV.VTFOLK_DKA3. If DFS\$DEFAULT_NAMESPACE is not defined, the following message is displayed:

```
%DFS-E-NAMSPMSG, Namespace component of access point is missing
```

2.3.2.3 Using the /LOCAL Qualifier

The ADD ACCESS_POINT and REMOVE ACCESS_POINT commands include a /LOCAL qualifier, which provides functionality similar to the /NODE qualifier described in Section 2.3.2.2.

As with MOUNT/NODE, the /LOCAL qualifier prevents any use of DECdns even if it is present. This enables you to use DECdfs without setting up a DECdns namespace and name server even on systems where DECdns is available.

When you use the /LOCAL qualifier, DECdfs checks the logical name DFS\$DEFAULT_NAMESPACE when an access point is specified without a namespace component. Therefore, you can include a command similar to the following in the DFSS\$CONFIG.COM startup file:

```
$ DEFINE /SYS DFS$DEFAULT_NAMESPACE DEC:
```

This allows un-prefixed access point names to be used in a manner consistent with traditional use on DECdns systems. For example, the following commands are valid if DFS\$DEFAULT_NAMESPACE is defined:

```
DFS> ADD ACCESS_POINT .LKG.S.MYDISK /LOCAL
DFS> MOUNT .LKG.S.MYDISK /NODE=VTFOLK
```

If you do not include the namespace name with ADD ACCESS_POINT or REMOVE ACCESS_POINT and DFS\$DEFAULT_NAMESPACE is not defined, DECdfs displays the following message:

```
%DFS-E-NAMSPMSG, Namespace component of access point is missing
```

Refer to Chapter 4 for more information on DFSCP commands.

Managing a DECdfs Server

2.3 Creating and Managing Access Points

2.3.3 Determining Access Point Information

You can find access point information by the DFS\$CONTROL command SHOW on a server node or on any existing client node with DECdfs and DECdns installed.

```
DFS> SHOW ACCESS /FULL access-point-name
```

If you specify the access point name, the command responds with a line showing the full access point name and the server node:

```
DFS> SHOW ACCESS /FULL .LKG.S.DFSDSK
DEC:.LKG.S.DFSDSK on BIGVAX::DUA30:[000000]
```

You can use this information in a DFS mount command as follows:

```
DFS> MOUNT DEC:.LKG.S.DFSDSK /NODE=BIGVAX
```

A logical name and other qualifiers may also be specified on the mount command line.

2.3.4 Changing Access Points

Once you have created an access point, its name must always see the same information or files. On some occasions, however, you might want to remove or change an access point or change the location of the directories to which an access point refers.

Caution

Use caution when removing or changing an access point, because doing so can disrupt the user environment on client systems.

To remove an access point name, enter the REMOVE ACCESS_POINT command. This command removes the name from the server database and from DECdns. However, it does not notify client systems that currently have the access point mounted. On these systems, any subsequent attempt to use the access point will fail except for operations on files that are currently open. Client users will receive an error code identifying the failure.

2.3.5 Removing Access Points Added with the /CLUSTER_ALIAS Qualifier

Removing access points from servers in a cluster sometimes requires extra steps. The original ADD ACCESS_POINT command registers the access point name in both the DECdns namespace and the local server database. The REMOVE ACCESS_POINT command attempts to remove the name from both the DECdns namespace and the local server database. However, if you registered the access point according to its server's cluster alias (that is, the ADD ACCESS_POINT command had the /CLUSTER_ALIAS qualifier), you must perform some extra procedures to remove the access point.

The REMOVE ACCESS_POINT command deletes the DECdns access point name entry. This command also removes the access point from the server's local database, but it does so only on the cluster member at which you enter the REMOVE command. An informational message reminds you of this.

To remove an access point that was registered by cluster alias, you must use the fully expanded access point name on all cluster members except the first server on which you entered the REMOVE ACCESS_POINT command.

Managing a DECdfs Server

2.3 Creating and Managing Access Points

To display the fully expanded access point name, enter the following command:

```
DFS> SHOW ACCESS_POINT /LOCAL /FULL
```

Remove the access point on each server by entering the REMOVE ACCESS_POINT command with this fully expanded access point name and the exact punctuation. When you enter this command at the first DECdfs server, you remove the access point name from the DECdns database. Subsequent REMOVE ACCESS_POINT commands at the other DECdfs servers in the cluster generate warnings that the access point is not in the DECdns namespace, but this does not indicate a problem. When you enter the fully expanded name at each server, you remove the access point from the server's local database.

To continue serving the access point on other cluster members, you can reregister the access point by using the ADD ACCESS_POINT/CLUSTER_ALIAS command on one of the other nodes. This replaces the access point name in the DECdns namespace. Disable the incoming alias on the node (or nodes) from which you removed the access point.

For DECnet Phase IV:

Use the following NCP command to disable the incoming alias:

```
NCP> SET OBJECT DFS$COM_ACP ALIAS INCOMING DISABLED
```

For DECnet Phase V:

Use the following NCL command to disable the incoming alias:

```
NCL> SET SESSION CONTROL APPLICATION DFS$COM_ACP INCOMING ALIAS FALSE
```

To disable the incoming alias permanently, edit the NET\$SESSION_STARTUP.NCL NCL script file.

2.3.6 Maintaining Consistency with DECdns

On certain occasions, DECdns can continue to supply outdated information to other nodes about access points on your server. Each time that you enter the ADD ACCESS_POINT command, you register the new access point name with DECdns. Until you explicitly remove the name by entering a REMOVE ACCESS_POINT command, DECdns retains it. DECdns therefore contains and supplies to other nodes information about unavailable access points on your server under the following conditions:

- Your node or its server becomes unavailable.
- You entered an access point interactively without adding it to the DFS\$SYSTARTUP file, and then the server stopped and restarted.

In either case, DECdns continues to supply outdated information (the access point name and the server's DECnet address information). If a new client attempts to mount the access point, the client receives a message stating that the access point is unavailable. If a client that previously mounted the access point attempts to read or write to an open file, an error occurs and returns an SSS_INCVOLLABEL error code. If such a client attempts to open a new file or to search a directory on the client device, the client attempts mount verification (see Section 3.4.5), which then fails.

While you cannot prevent the server from being unavailable occasionally, you can prevent the loss of access points by always adding new access points to the DFS\$SYSTARTUP file. If you stop the server permanently, be sure to enter a REMOVE ACCESS_POINT command for each access point on your system.

Managing a DECdfs Server

2.4 Protecting Server Files

2.4 Protecting Server Files

DECdfs handles security and file access according to OpenVMS conventions, but a few differences exist. DECdfs allows any user to enter a MOUNT command, regardless of volume-level protections. However, DECdfs performs access checking at the time of file access.

The server uses proxy access to verify a user's access to an account (see the *HP OpenVMS Guide to System Security*). The server does not perform an actual proxy login, however, since DECdfs accesses a node through the DECdfs server process. The server process performs file operations on behalf of the user at the client, and it impersonates the user by performing these operations in the name of the user's proxy account. Files created on behalf of a client user are therefore owned by the user's proxy account, not by the server process's account. Section 2.2 describes more fully how the DECdfs server validates user access.

2.5 Protecting Individual Files

DECdfs allows any user at any DECdfs client to mount an access point. On the server, however, standard OpenVMS file access protection applies to each file. The OpenVMS operating system uses a combination of user identification codes (UICs), privileges, protection settings, and access control lists (ACLs) to validate each file access according to the user's proxy account.

You can allow or disallow file operations by DECdfs users by specifying one of the following identifiers in an access control entry (ACE):

- DFSSSERVICE
- NETWORK

The DFSSSERVICE identifier applies only to users at DECdfs clients. The NETWORK identifier applies to users at DECdfs clients and all other network users.

You can explicitly place ACLs on DECdfs files only by logging in to the server system. The OpenVMS operating system recognizes the ACLs, so you can use them from the server to protect or grant access to the server files. However, DECdfs suppresses ACLs as seen from the client. A user with access to a DECdfs client device cannot create or view the ACLs on files residing at the server. Using the SET ACL/OBJECT_TYPE=FILE or EDIT/ACL command at a client to modify a server file displays an error message. Entering the DIRECTORY/SECURITY and DIRECTORY/FULL commands returns displays that omit the ACLs on any files in the directory listing.

2.6 Managing the Persona Cache

The server uses a *persona cache*, which contains information about individual client users. The server uses this information to determine whether a client user has permission to access individual files. This section explains how you control the operation of the persona cache.

When incoming user requests arrive at the server, the server process interacts with the OpenVMS operating system to create or access the requested files. To perform this operation on behalf of a particular user, the server builds a profile of that user. The server checks the NETPROXY.DAT file for the user's proxy account, the SYSUAF.DAT file for the user's privileges and UIC, and the RIGHTSLIST.DAT file for any identifiers granting additional rights.

The server places all of this information in a *persona block*. When creating or accessing a file on behalf of the user, the server process *impersonates* the user according to the persona block information. Although the server process itself is interacting with the OpenVMS file system, each file appears to be accessed by, and in accordance with the privileges of, the proxy account.

The persona cache helps to accelerate file access. After the server creates an individual persona block, the server reuses it each time that user accesses another file. This saves time because the server need not reread the NETPROXY.DAT, SYSUAF.DAT, and RIGHTSLIST.DAT files at each file access.

DECdfs automatically sets the size of the cache based on the number of users. As the number of users increases, DECdfs borrows from nonpaged pool to meet the demand. When the number of users decreases, DECdfs returns unused blocks to nonpaged pool.

2.6.1 Specifying the Lifetime of Persona Blocks

Persona blocks have a specified lifetime, which you can adjust by using the SET SERVER/PERSONA_CACHE=UPDATE_INTERVAL command. When the persona block for a user expires, the server validates the user's next access by reading the three authorization files and building a new block. This ensures that, at a specified interval, the DECdfs server automatically incorporates any changes that you make to any of the authorization files.

If DECdfs users at client systems complain that the response time for opening files is too long, consider lengthening the update interval.

2.6.2 Flushing the Cache

You can flush the persona cache by using the SET SERVER/INVALIDATE_PERSONA_CACHE command. This forces the server to build a completely new cache, validating each new user access from the authorization files. You can flush the persona cache after making changes to access rights or proxy accounts without waiting for the update interval to expire.

You need to restart the server if you have replaced the RIGHTSLIST.DAT file by copying the file or changing the file's logical name assignment. You do not need to restart the server if you have replaced or copied the NETPROXY.DAT file or SYSUAF.DAT file or if you have changed either of these two files' logical name assignments.

2.6.3 Displaying Cache Counters

Table 2-1 lists and explains the counters that are available for the persona cache. To display the persona cache counters, use the following DFSS\$CONTROL command:

```
DFS>SHOW SERVER/COUNTERS
```

Table 2-1 Persona Cache Counters

Counter	Description
Persona Blocks Active	The current number of simultaneously active persona blocks.

(continued on next page)

Managing a DECdfs Server

2.6 Managing the Persona Cache

Table 2-1 (Cont.) Persona Cache Counters

Counter	Description
Maximum Persona Blocks Active	The highest number of simultaneously active persona blocks since the server started.
Persona Cache Blocks Allocated	The current number of allocated persona blocks. This includes a count of both currently active and inactive persona blocks.
Maximum Persona Cache Blocks Allocated	The highest number of allocated persona blocks since the server started. This tells how large the cache has been since the last startup.
Persona Cache Hits	The number of times the server was able to reuse an existing persona block to satisfy an incoming file request.
Persona Cache Misses	The number of times the server was forced to build a new persona block to satisfy a new file request.
Persona Cache Threshold	The number of preallocated persona blocks that the server maintains.

2.7 Managing the Data Cache

Managing the data cache involves periodically using the server counters to monitor DECdfs performance, reassess server use, and tune the data cache parameters to maintain good performance.

The DECdfs server data cache improves performance by caching blocks of files to expedite the repeated use of files or parts of files. Many files on a system, such as command procedures or executable files, are used repeatedly. In addition, during access of a file, the same blocks in the file are often read and written many times. DECdfs stores file data in its data cache to eliminate unnecessary disk accesses. The caching takes place on both read and write requests.

To further improve performance, DECdfs *prefetches* subsequent blocks from files being accessed sequentially; that is, during sequential file access operations, DECdfs anticipates your needs, moving data from the disk to the cache so it is available when you actually request it.

The server's data cache is a write-through cache. It does not affect standard RMS caching, which occurs on the client system.

2.7.1 Specifying the Size of the Cache

To specify the size of the data cache, enter the following command:

```
DFS> SET SERVER/DATA_CACHE=COUNT_OF_BUFFERS
```

This command allocates a certain number of buffers from nonpaged pool to use in the data cache. The size of each buffer is fixed. Each buffer takes 8192 bytes of data plus 50 bytes of header information, for a total of 8242 bytes.

If you increase the count of buffers past the default value, increase the amount of nonpaged pool (the NPAGEDYN parameter) by a corresponding number of bytes. To do so, modify the SYSSYSTEM:MODPARAMS.DAT file and rerun AUTOGEN (see the *HP OpenVMS System Manager's Manual*).

2.7.2 Specifying the Per-File Quota

The file buffer quota improves performance as follows:

- The quota prevents a large sequentially accessed file from taking all the cache buffers while other files are in use.
- The server can ignore the quota when necessary. Then the server can better meet the needs of large and frequently accessed files when no or few other files are in use.

You can specify how many file cache buffers a single file uses by entering the following command:

```
DFS> SET SERVER/DATA_CACHE=FILE_BUFFER_QUOTA
```

When a user makes an initial request for read access to a file, the server moves data from the disk to the cache. As the user continues to request read and write access to the same file, the server continues to allocate buffers to the file. Once the server reaches the quota, however, it reuses a file's buffers, beginning with the one least recently used. If that buffer is currently in use, the server ignores the quota and uses the least recently used available buffer in the cache. If no buffer is currently available in the cache, the file request waits.

If you choose to adjust the file buffer quota, consider what types of files you use with DECdfs. If users repeatedly access one large file, such as an executable file or a shared design template, a high file quota can be useful. Adjustments to this value should reflect the patterns of use at your site. To monitor the use and efficiency of the cache, use the SHOW SERVER/COUNTERS command.

2.7.3 Displaying Cache Counters

Table 2-2 lists and explains the data cache counters. To display the data cache counters, use the following DFSS\$CONTROL command:

```
DFS> SHOW SERVER/COUNTERS
```

Table 2-2 Data Cache Counters

Counter	Description
Data Cache Full	The number of times that the least recently used buffer was currently in use and a request had to wait for a buffer.
Data Cache Hits	The number of times that the server was able to satisfy a read request by finding a requested block in the cache. The server therefore avoided accessing the disk.
Data Cache Misses	The number of times that the server was unable to satisfy a read request by finding a requested block in the cache. The server was therefore forced to access the disk.
Data Cache Quota Exceeded	The number of times that a particular file used more buffers than its specified quota.
Physical Writes	The number of times that the server wrote a block to disk.

(continued on next page)

Managing a DECdfs Server

2.7 Managing the Data Cache

Table 2–2 (Cont.) Data Cache Counters

Counter	Description
Physical Reads	The number of times that the server read a requested block from disk.

Frequent high numbers for the Data Cache Full counter indicate that your server is very busy. When the cache is full and file requests wait for buffering, performance can degrade. Monitor this counter and consider raising the buffer count value if necessary.

Interpret the hits-to-misses ratio according to the application for which you use DECdfs. Sequential accesses should produce a high hits-to-misses ratio because of the prefetching DECdfs performs. Nonsequential accesses (or a very busy server with frequent reuse of cache blocks) can produce a low hits-to-misses ratio. To correct a consistently low hits-to-misses ratio, consider increasing the buffer count value by using the SET SERVER/DATA_CACHE=COUNT_OF_BUFFERS command.

The Physical Writes and Physical Reads counters indicate the number of times the server performed a disk I/O operation.

2.8 Using a Cluster as a DECdfs Server

You can make a device and directory available as an access point from a cluster system by using a cluster alias. A cluster alias serves a single access point from all cluster members when the incoming alias is enabled.

Sections 2.8.1 and 2.8.2 explain how to serve an access point from a cluster alias and from individual cluster members.

2.8.1 Serving an Access Point from a Cluster Alias

To create an access point that is registered by the cluster alias, follow these steps:

1. Install and start the DECdfs server on each node in the cluster for which the incoming alias is enabled.
2. Add the access point by using the /CLUSTER_ALIAS qualifier with the ADD ACCESS_POINT command. This supplies DECdfs with the cluster alias instead of the node address as the access point's location.
3. Repeat the same ADD ACCESS_POINT command on each DECdfs server node in the cluster.

After you have completed these steps, a client system that mounts the access point connects to the cluster rather than to a specific node. DECnet software at the cluster chooses the node that will serve the client. The failure of one node does not prevent a DECdfs client from mounting an access point. If the server node involved in a DECdfs communication session becomes unavailable, another cluster member can respond when the DECdfs client tries to reestablish the connection. This allows the DECdfs session to proceed with minimal interruption to the user.

2.8.2 Serving an Access Point from Individual Cluster Members

If you do not enable the cluster alias, or if you have not installed the DECdfs server software on all members of the cluster, you can still serve the same device and directory from multiple nodes. The access point, however, must have a different name on each node. The access point name simply represents an alternative route to the same device and directory.

2.9 Stopping and Starting DECdfs on Your System

Before stopping DECdfs on your system, it is important to notify users. You can determine whether users are currently accessing the server by entering the following command:

```
DFS> SHOW SERVER /USERS
```

You can determine whether DECdfs users are accessing a local client by entering the SHOW COMMUNICATION/CURRENT command and looking for active outbound connections. This procedure does not identify users by name. However, you can use the DCL REPLY command to notify those users before stopping the server.

To stop DECdfs on your system without aborting user file access, enter the DFSS\$CONTROL command SHUTDOWN COMMUNICATION. This allows existing communication sessions to complete but refuses new requests. With communications shut down, the following DECdfs commands do not function:

- SET SERVER/INVALIDATE_PERSONA_CACHE
- SHOW SERVER/USERS
- SHOW SERVER/ACTIVE

To stop DECdfs operations immediately, use the STOP COMMUNICATION command. This command immediately aborts current user file operations and stops the Communication Entity and server.

Note

For DECnet Phase IV:

If you stop DECnet—by entering the following NCP command, for example—the DECdfs communication and server ancillary control processes also stop:

```
NCP> SET EXECUTOR STATE OFF
```

For DECnet Phase V:

If you stop DECnet—by entering any of the following commands to disable the data link, for example—all connections are lost. DECdfs will be unable to establish connections to disk drives until the network is started.

```
NCL> DISABLE NODE 0 ROUTING  
NCL> DISABLE NODE 0 NSP  
NCL> DISABLE NODE 0 SESSION CONTROL
```

Managing a DECdfs Server

2.9 Stopping and Starting DECdfs on Your System

To start DECdfs on your system, run the file
SYS\$STARTUP:DF\$STARTUP.COM.

Note

Make sure DECnet is running before you restart DECdfs. Restarting DECnet or restarting the Communication Entity does not restart the DECdfs server; you must explicitly execute the DECdfs startup command file.

Managing a DECdfs Client

Managing a DECdfs for OpenVMS client involves coordinating the values of certain interrelated parameters on your system and then mounting DECdfs access points. This creates the client devices on your system.

This chapter describes the following management tasks:

- Setting system parameters
- Mounting access points
- Displaying client device information
- Using the client device
- Performing checksum comparisons on DECdfs connections
- Printing files from a client device
- Using the Backup Utility with a client device
- Using a cluster as a DECdfs client
- Stopping and starting DECdfs on your system

Most of these tasks involve the use of DFS\$CONTROL commands and qualifiers. For complete information on a specific command, see Chapter 4. For an overall perspective on DECdfs, read Chapter 2, even if you manage a client-only node. Certain topics covered in Chapter 2 affect both the client and server.

After you read this chapter, set the necessary system and network parameters and edit the DFS\$CONFIG.COM and DFS\$SYSTARTUP.COM files. You can then start DECdfs on your system by executing the DFS\$STARTUP.COM file.

Note

A major difference between the server and client is as follows: the server resides in its own process on your system, whereas no explicit client process exists. The client resides in the DFSC device driver. Managing a client involves managing the client devices.

3.1 Setting System Parameters

Running DECdfs on a client system may require that you adjust the SYSGEN parameter NPAGEDYN. Adjust this before installation, as described in the <REFERENCE>(DFS_inst_guide).

DECdfs provides excellent performance when your system uses the default network and RMS parameters. However, you might improve DECdfs client performance by setting these parameters as described in Appendix C.

Managing a DECdfs Client

3.2 Mounting Access Points

3.2 Mounting Access Points

To mount an access point, use the DFSS\$CONTROL command MOUNT. You can mount only access points that the server manager has added. How access points are added and mounted is described in Section 2.3.2. For further information on the MOUNT command and its qualifiers, refer to Chapter 4.

To display a list of the available access points, use the SHOW ACCESS_POINT command. To simplify operation, place the MOUNT commands in the DFSS\$SYSTARTUP command file.

The MOUNT command mounts the client device to enable access by all users and jobs on the client system. That is, the DFSC device can be accessed by users other than the one who mounted it. However, access to files on the server is controlled based on the client user making the reference, not the user who mounted the device.

If /SYSTEM or /GROUP qualifiers are used, any associated logical name is defined in the system or group logical name table respectively. Also, any subsequent attempts to mount the same access point will fail with the message:

```
%MOUNT-VOLALRMNT, another volume of same label already mounted
```

If neither the /SYSTEM or /GROUP qualifier is specified, the mount command allocates a new DFSC unit even if another user already has the same access point mounted.

3.2.1 Assigning Device Unit Numbers

Mounting an access point creates a new client device on your system. DECdfs copies this device from the template device DFSC0:. DECdfs creates DFSC0: at startup, when it loads DFSCDRIVER.EXE, the client driver image. DECdfs then copies the I/O database data structures for each subsequent DFSC device from the template. As you mount access points, OpenVMS sequentially assigns a unit number to each new DFSC device, starting with unit number 1001. The first access point you mount creates DFSC1001:, the second access point creates DFSC1002:, and so on.

The MOUNT command has a /DEVICE qualifier that allows you to specify the device unit number. If you manage an OpenVMS Cluster system as a DECdfs client, this feature ensures that the same device number is mounted on all cluster members. Otherwise, DECdfs's default numbering could assign different device unit numbers to the same access point on different cluster members.

3.2.2 Assigning Logical Names

When you mount an access point, you can use the MOUNT command parameter local-logical-name to assign a logical name to the DFSC device. Compaq recommends that you use logical names. Because the order in which DFSC devices are created can vary, their unit numbers can also vary. Referring to the devices by consistent logical names simplifies both management and use.

3.2.3 Specifying Volume Names

The MOUNT command's /VOLUME_NAME qualifier allows you to specify a volume name for the client device. This name identifies the device in the display from the DCL command SHOW DEVICE.

The volume name has a limit of 12 characters. If you do not specify a volume name, the access point name becomes the default volume name if it has 12 or fewer characters. If the access point name has more than 12 characters, the default volume name consists of the first 5 characters of the access point name, 2 periods (.), and the last 5 characters of the access point name.

Note

Specifying a volume name for the client device does not affect the volume name on the actual device at the server.

3.2.4 Enabling Data Checking

Data checking causes the server to ensure the integrity of data between the disk and the OpenVMS system on the server. When you mount an access point, you can request a data check on read-only operations, write-only operations, or both read and write operations for the client device. To do so, include the /DATA_CHECK qualifier with the MOUNT command.

Data checking takes place at the server. You can request data checking on the client device whether or not the system manager at the server mounted the actual physical device with data checking enabled. If the physical device has data checking enabled, your request does not cause redundant data checking. If the device does not have data checking enabled, your request causes data checking only on your own client's use of the access point.

For a description of data checking on a disk, see the *HP OpenVMS I/O User's Reference Manual*.

3.2.5 Mounting Alternative Access Points

An access point can be served by a cluster as well as by an individual node. If the server is a common-environment cluster, the DECdfs manager can register the cluster alias as the access point's location. This allows any node to process incoming requests for the access point. Consequently, the client has to mount only the cluster device. For more information on OpenVMS Cluster systems, see the *HP OpenVMS Cluster Systems* manual. For more information on cluster aliases, see the *DECnet for OpenVMS Network Management Utilities* manual or the <REFERENCE>(DNPLUS_OVMS_NET_MGMT) manual.

If the server manager does not want all nodes with incoming alias enabled to serve the access point, he or she can add the access point from more than one node, giving the access point a different, alternative name on each. The client manager can then choose an access point name and can also select another name later if problems arise with the first choice.

3.3 Displaying Client Device Information

The DCL command SHOW DEVICE provides information about the client devices on your system. The device information in the display resembles that for other devices, except that DECdfs does not report the number of free blocks for a client device. The Free Blocks field displays a row of asterisks, as in the following example:

Managing a DECdfs Client

3.3 Displaying Client Device Information

```
$ SHOW DEVICE DFSC1:
Device Device Error Volume Free Trans Mnt
Name Status Count Label Blocks Count Cnt
DFSC1: Mounted 0 HELP ***** 2 1
```

With the /FULL qualifier, the command displays the number 4294967295 in the Free Blocks field. This number is always the same and does not actually represent a count of free blocks.

The DFSSCONTROL command SHOW CLIENT provides information on a specific client device. For the specified device, the command displays the device status, name of the associated access point, the server node, and number of free blocks. For example:

```
DFS> SHOW CLIENT SATURN

Client Device SATURN (Translates to _DFSC1001:)
Status = Available
Access Point = DEC:.LKG.S.TANTS.RANGER_SATURN
Node = TOOTER
Free blocks = 71358
```

Optionally, you can also request activity counters for the device with the /COUNTERS qualifier. The /ALL qualifier requests the counters and above information. Table 3–1 lists and explains the client counters. The counters indicate use starting from the time that you created the device by mounting an access point.

Table 3–1 Client Counters

Counter	Description
File Operations Performed	The total number of all file (XQP) QIO functions issued to the device.
Bytes Read	The total number of bytes read from this device by user IOS_READVBLK function codes.
Bytes Written	The total number of bytes written to this device by user IOS_WRITEVBLK function codes.
Files Opened	The total number of files that this device has opened.
Mount Verifications Tried	The total number of times that this device attempted to recover from the unavailability of a server node, a server, the Communication Entity, or the DECnet network.

Use these client counters to measure DECdfs use at your system. Some mount verifications probably will occur routinely. Once you know the normal frequency of mount verifications, you can monitor the Mount Verifications Tried counter to track potential DECdfs problems. For more information about mount verification, see Section 3.4.5.

3.4 Using the Client Device

Using a DECdfs client device differs from using a device that is actually local in a few ways, as follows:

- Printing server-based files on a client
- User identification codes (UICs) on server files
- Access control lists (ACLs) on server files

- Reporting DECdfs error conditions
- DECdfs mount verification
- Partially mounted devices

The following sections explain these differences in use.

3.4.1 Printing Server-Based Files on a Client

Before you can use the client device from your system, the DECdfs server manager must set up proxy accounts. Each user at your system who accesses files at the server does so through a proxy account or a default account.

Printing operations require special treatment in addition to the usual proxy and default accounts. To print files from the client device, your local SYSTEM account must have proxy access to the server node.

For print access to the server, ask the server manager to implement one of the suggestions in Section 2.2.4.

3.4.2 User Identification Codes on Server Files

DECdfs Version 1.1 and higher software versions convert server user identification codes (UICs) to client UICs if the proxy account owns files on the server and if you use the /OWNER, /SECURITY, or /FULL qualifier with the directory command. This command displays the correct alphanumeric file owner on a DECdfs device, even when the DECdfs client and server nodes do not have coordinated UICs. However, users might have difficulty performing the following operations when UICs are not coordinated on the DECdfs client and server nodes:

- Files that are not owned by the user's proxy account are displayed with possibly misleading or confusing owner information.
- Some operations, such as BACKUP, might fail if the target directory is not owned by the proxy account. You can correct this problem by using the /BY_OWNER=PARENT or /BY_OWNER=ORIGINAL qualifier to the BACKUP command.

For more information about UICs, see Section 2.2.2.1.

3.4.3 Access Control Lists on Server Files

Access control lists (ACLs) are invalid at the DFSC device; you cannot create or view the ACLs on files that reside at the server. The results of attempting to do so are as follows:

- The displays for the DIRECTORY/SECURITY, DIRECTORY/ACL, and DIRECTORY/FULL commands omit the ACLs.
- The following commands return error messages:

```
SET ACL/OBJECT_TYPE=FILE
EDIT/ACL
SET FILE/[NO]SEMANTICS
SET FILE/[NO]STATISTICS
```

- DECdfs provides limited support for Digital Data Interchange Format (DDIF) tagged files. You can create and read DDIF files on a DECdfs device when the DECdfs client node is running OpenVMS Version 5.1 or later versions. In this instance, the DDIF application creates the DDIF tag and applies it to the created files. You can also set DDIF tags manually by entering the DCL SET FILE/[NO]SEMANTICS COMMAND at the server.

Managing a DECdfs Client

3.4 Using the Client Device

Use the DIRECTORY /FULL command to determine whether a DDIF file on a DECdfs device is tagged. Note that the Backup Utility does not preserve the DDIF tag or the DDIF stored semantics for data files on a DECdfs device.

- If you use MONITOR RMS to monitor file activity on a DECdfs client device, the MONITOR Utility returns activity information if the file ACEs have been set locally (on the server) using the DCL SET FILE/[NO]STATISTICS COMMAND.

DECdfs may return the error codes shown in Table 3–2 if you attempt to manipulate ACLs through DECdfs.

Table 3–2 ACL-Related Error Codes

Error Code	Condition
SS\$_NOACLSUPPORT	Occurs when you try to explicitly alter the ACL of a file on a DECdfs client device.
SS\$_NONLOCAL	Occurs when you try to open a journaled file for write access or set a file as journaled or not journaled on a DECdfs client device.

3.4.4 DECdfs Error Conditions

A variety of conditions can arise on the client or server, or on the network, that affect the outcome of DECdfs operations. When an operation is initiated by a command in DFSS\$CONTROL, DECdfs is able to diagnose and report any exception conditions using the messages listed in Appendix A. When operations are initiated by general system services, however, the full set of DECdfs error condition codes are not available, and a less obvious, general message may be reported.

For example, if a MOUNT command identifies an access point that is not currently available from its usual server, DECdfs reports the condition as follows:

```
DFS> MOUNT DEC:.LKG.S.DFSDEV.OUTPOS_XX /NODE=OUTPOS OPX
%MOUNT-MOUNTED, DEC:.LKG.S.DFSDEV.ÖUTPOS_XX mounted on _DFSC1003:
%DFS-W-NOTSERVED, Access point is not presently being served
```

However, if the same condition is present when a general file access is made, only a general message is reported:

```
$ DIR OPX:[JONES]
%DIRECT-OPENIN, error opening OPX:[JONES]*.*;* as input
-RMS-DNF, directory not found
-SYSTEM-INCVOLLABEL, incorrect volume label
```

The most common of these messages are shown in Table 3–3.

Additionally, you can determine the current status of a DFSC device by using the SHOW CLIENT command in DFSS\$CONTROL, for example:

```
DFS> SHOW CLIENT OPX
Client Device OPX (Translates to _DFSC1004:)
Status          = Available
Access Point    = DEC:.LKG.S.DFSDEV.OUTPOS_XX
Node            = OUTPOS
Free blocks     = -1
Access point is not presently being served
```

The last line of output gives the specific DECdfs status of the access point, including any conditions that may make it inaccessible.

3.4.5 DECdfs Mount Verification

When a disk becomes unavailable on an OpenVMS system, the OpenVMS operating system performs mount verification. Mount verification is the process by which the OpenVMS operating system repeatedly attempts to recover from a disk failure or stoppage and to reestablish use of the disk. Similarly, when the client cannot satisfy certain user requests, it performs mount verification to recover from the failure and reestablish DECdfs service.

The client performs mount verification and retries a user request to open a file or search a directory if the request fails for one of the following reasons:

- The DECnet network or the Communication Entity has stopped on the client.
- The DECnet network, the Communication Entity, or the server software has stopped on the server.
- The access point with which the client device is associated has been removed.

If I/O operations within open files fail for these reasons, DECdfs does not attempt mount verification. Instead, you must close and then reopen any open files. Any operation except CLOSE returns an SSS_ABORT error code. Even if opening a new file restores the link, you cannot use the old file without reopening it.

During the verification process, the client device repeatedly attempts the mount for a short time. If the mount succeeds during that time, mount verification succeeds. A successful mount verification, therefore, means that the original user request succeeds, perhaps with just a delay in response time. If the mount does not succeed during that time, mount verification times out and fails. For example, suppose the manager at the server enters the DFSSCONTROL STOP SERVER command but follows immediately with the START SERVER command. While the server is stopped, client requests fail and mount verification begins. When the server restarts and access points are added again, mount verification succeeds.

Canceling the user operation that triggered mount verification also cancels mount verification. For example, if mount verification starts in response to a DIRECTORY command, and the user presses Ctrl/Y, mount verification stops.

During mount verification, the client sends network class messages to OPCOM, starting with the second try. These messages explain the cause and describe the state of the verification process. The example following, in which the mount verification was caused by an unavailable remote server, shows an OPCOM mount verification message for DECdfs

```
%%%%%%%%%% OPCOM 8-JAN-1999 10:17:11.56 %%%%%%%%%%%  
Message from user DFS_CLIENT  
DFS server for access point FIN.MYSTRY_DUAL is not running  
DFS client mount verification in progress on device _DFSC1:
```

The next example reports that an access point was removed at the server:

```
%%%%%%%%%% OPCOM 8-JAN-1999 10:18:53.31 %%%%%%%%%%%  
Message from user DFS_CLIENT  
DFS client is verifying access point .REDHED.WATSON  
DFS client mount verification in progress on device _DFSC2:
```

Managing a DECdfs Client

3.4 Using the Client Device

If mount verification fails, the application that triggered it receives one of the error codes listed in Table 3–3.

Table 3–3 Mount Verification Error Codes

Error Code	Condition
SS\$DEVNOTMOUNT	DECnet or the Communication Entity is unavailable at the client.
SS\$INCVOLLABEL	The server is running, but the access point is invalid.
SS\$INVLOGIN	The Communication Entity is unavailable at the server.
SS\$NOLISTENER	The server is not running.
SS\$UNREACHABLE	DECnet is unavailable at the server.

3.4.6 Partially Mounted Devices

DECdfs supports partially mounted devices so that you enter a MOUNT command only once for a client device, even if DECdfs does not complete the mount because the server is unavailable.

While the device is partially mounted, client requests trigger mount verification. After the server becomes available, the next mount verification succeeds, which completes the mount operation and the client request.

3.5 Performing Checksum Comparisons on DECdfs Connections

DECdfs can provide a layer of data integrity above the DECnet level by performing checksum comparisons. To request or stop checksumming, use the DF\$CONTROL command SET COMMUNICATION/[NO]CHECKSUM.

DECdfs checksum comparisons ensure the integrity of the DECnet link. Whenever DECdfs finds a checksum error, it determines that the DECnet link is unreliable and disconnects the logical link. You can enable and disable checksumming only from a client system; the actual checksum comparison occurs at both the client and server. DECdfs reports a checksum error to the node that detects the checksum error and the node that sent the faulty packet.

When you install DECdfs, checksumming is disabled by default for the following two reasons:

- Networks usually provide sufficient error detection and correction at the network interface level.
- Using DECdfs checksumming increases CPU overhead.

If your network is prone to errors, you should enable the DECdfs checksum option by changing the command in SY\$MANAGER:DF\$CONFIG.COM to SET COMMUNICATION/CHECKSUM. Then monitor OPCOM messages for checksum failures or use the SHOW COMMUNICATION/COUNTER command to check for a nonzero checksum error counter. Whenever you change the network configuration at your site (for example, when you add new network controller boards or Ethernet segments), you can enable checksumming for a short time to check the links again.

Both checksum comparisons and data checks (which you request with the MOUNT/DATA_CHECK command) test data integrity, but they are very different. A checksum comparison ensures the integrity of data traveling between

Managing a DECdfs Client

3.5 Performing Checksum Comparisons on DECdfs Connections

the server and client. A data check ensures the integrity of data between the disk and the OpenVMS system on the server.

3.6 Printing Files from a Client Device

The MOUNT command entered at the client must include the /SYSTEM qualifier to ensure that the DECdfs device is available systemwide on the client.

If the client is a cluster, the MOUNT command entered at the client must also include the /DEVICE qualifier. This ensures that all nodes in the cluster use the same device name to see a particular client device. Using consistent device names on all cluster members is essential for successful printing functions. Consistent names allow the print symbiont to find a file regardless of the node at which the print command is entered. See Section 3.8 for more information about mounting DECdfs devices in a cluster.

3.7 Using the OpenVMS Backup Utility with a Client Device

You can use the Backup Utility (BACKUP) to back up files to or from a DFSC device. However, because DFSC devices do not support ACLs, the following limitations exist:

- Backing up files from a DFSC device does not save ACL information. Therefore, a subsequent restore of a saveset created this way will not restore the ACLs.
- Restoring files to a DFSC device will not restore ACLs even if the saveset was made from a local device and does contain ACL information.
- Performing a file copy operation with BACKUP does not copy ACLs if either source or destination is a DFSC device.

Also note that the BACKUP qualifiers /PHYSICAL, /IMAGE, and /FAST cannot be used with DFSC devices.

For more information on the Backup Utility, see the *HP OpenVMS System Management Utilities Reference Manual*.

3.8 Using a Cluster as a DECdfs Client

To use a cluster as a DECdfs client, you must become familiar with the information in the following sections regarding cluster aliases and submitting print and batch jobs.

3.8.1 Using Cluster Aliases

At a cluster, it is advantageous to use the cluster alias in outgoing communication with DECdfs servers. Using the cluster identification rather than the individual node identification simplifies management by allowing the server manager to set up proxy accounts according to the cluster alias. This ensures that the user has access to the server from any node in the client cluster. To ensure that DECdfs uses the cluster alias, perform the following steps:

1. Define the cluster alias on each node in the cluster.

If you have not already defined the cluster alias in your node's permanent database, enter the appropriate command, as follows:

Managing a DECdfs Client

3.8 Using a Cluster as a DECdfs Client

For DECnet Phase IV:

```
NCP> DEFINE EXECUTOR ALIAS NODE cluster-alias-name
```

Use this command on each node in your cluster. Using SET instead of DEFINE in this command would affect your node's volatile database. See Appendix C for information on the differences between the NCP commands SET and DEFINE.

For DECnet Phase V:

```
NCP> CREATE [NODE node-id] ALIAS
NCP> CREATE [NODE node-id] ALIAS PORT port-name NODE ID
NCP> SET [NODE node-id] ALIAS PORT port-name SELECTION WEIGHT integer
NCP> ENABLE NODE ALIAS PORT port-name
```

Replace *node-id* with the name or address of the node on which you are entering the command and replace *port-name* with the DECdns full name of the cluster alias, such as .SITE.GROUP.CLUSTER_ALIAS. To define the cluster alias on all nodes in the cluster, enter these commands at each node. An alternate method of defining the cluster alias on each node is to run the command file NETCONFIGURE.COM in the SYSSMANAGER directory. For more information on NETCONFIGURE.COM, see the *DECnet/OSI for OpenVMS Installation and Configuration* manual.

2. Enable DECnet to send proxy information with outgoing logical link requests on behalf of the DECdfs Communication Entity. Add the appropriate command to the DFS\$SYSTARTUP file, as follows:

For DECnet Phase IV:

```
MCR NCP SET OBJECT DFS$COM_ACP ALIAS OUTGOING ENABLED
```

For DECnet Phase V:

```
MCR NCL CREATE [NODE node-id] SESSION CONTROL APPLICATION DFS$COM_ACP
MCR NCL SET [NODE node-id] SESSION CONTROL DFS$COM_ACP OUTGOING
ALIAS boolean
```

Replace *node-id* with the name or the address of the node. Replace *boolean* with TRUE. Enter these commands at each node in the cluster. To make the setting permanent, add these commands to the NET\$APPLICATION_STARTUP.NCL script file in the SYSSMANAGER directory.

Outgoing requests from your client's Communication Entity then contain the cluster name instead of the individual node name.

3.8.2 Submitting Print and Batch Jobs

In a DECdfs client cluster, you can submit print and batch jobs on any cluster member's queues if both of the following events have occurred:

- You mounted the access point using the /DEVICE qualifier to the MOUNT command.
- The device specification was the same for all the cluster members.

3.9 Stopping and Starting DECdfs on Your System

It may become necessary to stop DECdfs on your system; for example, if security should be compromised and you need to stop all file access immediately.

Managing a DECdfs Client

3.9 Stopping and Starting DECdfs on Your System

Before you stop DECdfs, notify users of your intentions. You can determine whether users are active on a DECdfs client by entering the SHOW COMMUNICATION/CURRENT command and looking for active outbound connections. This procedure does not identify users by name, but you can use the DCL REPLY/ALL command to notify all users on each client.

To stop DECdfs on your system without aborting user file access, enter the DFSS\$CONTROL command SHUTDOWN COMMUNICATION. This allows existing communication sessions to complete but refuses new requests.

To stop DECdfs operations immediately, use the STOP COMMUNICATION command. Use this command with caution; it immediately aborts current user file operations and stops the Communication Entity and client.

Note

Observe these cautions:

For DECnet Phase IV:

If you stop DECnet (by entering the NCP command SET EXECUTOR STATE OFF, for example), the DECdfs communication process also stops.

For DECnet Phase V:

If you stop DECnet (by disabling the data link, for example) all connections are lost. DECdfs will be unable to establish connections to disk drives until the network is started.

To start DECdfs on your system, run the startup command file SYS\$STARTUP:DFS\$STARTUP.COM.

Note

Ensure that DECnet is running before you restart DECdfs. Restarting DECnet or restarting the Communication Entity does not restart DECdfs; you must explicitly execute the DECdfs startup command file.

DFSS\$CONTROL Commands

This chapter contains a list of the DFSS\$CONTROL commands and their definitions. Many of the DFSS\$CONTROL commands are the same as or similar to DCL commands. All DFSS\$CONTROL commands comply with DCL command syntax conventions. The basic command syntax is as follows:

COMMAND/QUALIFIER=(option,option) parameter

You can abbreviate DFSS\$CONTROL commands, qualifiers, and keywords. You can enter them in uppercase, lowercase, or any combination of uppercase and lowercase. If you specify only one option with a qualifier, you need not use the parentheses.

For more information on command syntax, see the *OpenVMS User's Manual*.

You can use DFSS\$CONTROL commands either interactively or in DECdfs command files. To invoke the DFSS\$CONTROL program interactively, enter the following command:

```
$ RUN SYS$SYSTEM:DFSS$CONTROL
```

DECdfs installation does not modify the system DCLTABLES to add a DFSS\$CONTROL command, but a foreign command can be used as follows:

```
DFSCP == "$DFSS$CONTROL"
```

With this symbol definition, all of the commands documented in this chapter can be entered interactively at the DCL prompt by preceding them with DFSCP, for example:

```
$ DFSCP SHOW COMMUNICATION
$ DFSCP MOUNT .DATA_DISK LCLNAME
```

Also, the control program can be run for repeated DFS commands by entering:

```
$ DFSCP
DFS>
```

To get help on DFSS\$CONTROL commands, enter the HELP command from the DFS> prompt as follows:

```
DFS> HELP
```

You can use standard command-line editing features from the DFS> prompt.

The SYS\$STARTUP:DFSS\$CONFIG.COM file is an example of how to use DFSS\$CONTROL commands in a command file.

Note

The examples in this chapter illustrate the interactive use of commands, even for those that you typically enter from a command file.

DFS\$CONTROL Commands

You can use the Help Message utility to access explanations of messages returned in response to DFS\$CONTROL commands. For information on using the Help Message utility, see the *OpenVMS System Messages: Companion Guide for Help Message Users* or enter HELP HELP/MESSAGE at the DCL prompt (\$). Appendix A in this manual also provides descriptions of DECdfs messages.

ADD ACCESS_POINT

Registers an access point name in the DECdfs server database and the Digital Distributed Name Service (DECdns).

Format

```
ADD ACCESS_POINT ap-name directory-name
```

Parameters

ap-name

The access point name stored by the DECdfs server and DECdns.

directory-name

The device and directory to which the access point refers. The device name is required and must be followed by a colon (:). The directory name is optional; the default directory is the device's master file directory (MFD). For example, if you specify DUA3:, the access point refers to DUA3:[000000]. You can substitute a system-rooted logical for a device name.

Description

This command makes an access point available to DECdfs clients by adding its name to DECdns and to the local server database. Insert the command into the DFSS\$SYSTARTUP command file to register each access point at startup time. Each command line takes one access point name.

Entering this command interactively registers the access point with DECdns but keeps the server database entry alive only until the server stops. Once the server stops, the display for the SHOW ACCESS POINT command lists the access point but notes that it is unavailable. Editing the DFSS\$SYSTARTUP file each time you add an access point interactively will ensure that DECdns and your server database contain the same information.

You must have the SYSNAM and OPER privileges to use this command.

Qualifier

/CLUSTER_ALIAS

Gives the cluster alias, rather than the individual node's DECnet address information, to DECdns when registering the access point. To use this qualifier, you must use the identical command on each cluster member that has the incoming alias enabled.

/LOCAL

Registers the access point with the local DECdfs server database but not the DECdns server namespace. This is what happens by default when you add an access point on a system on which DECdns is not available. The /LOCAL qualifier makes this an option on systems where DECdns is available.

The access point name for an access point added with the /LOCAL qualifier must include the namespace name unless you have defined the logical name DFSS\$DEFAULT_NAMESPACE in the DFSS\$CONFIG.COM file.

Access points added with the /LOCAL qualifier must be mounted with the /NODE qualifier.

ADD ACCESS_POINT

Examples

1. DFS> ADD ACCESS_POINT DEPARTMENT_FINANCE USER\$34:
DFS>

This command adds the access point name DEPARTMENT_FINANCE. The access point refers to the directory USER\$34:[000000].

2. DFS> ADD ACCESS_POINT BAKER_STREET.221B DISK\$CASES:[MORIARTY]
DFS>

This command registers the access point BAKER_STREET.221B. The access point refers to the directory DISK\$CASES:[MORIARTY].

3. DFS> ADD ACCESS_POINT BAKER_STREET.WATSON -
_DFS> DISK\$CASES:[WATSON]/CLUSTER_ALIAS
DFS>

This command registers the access point BAKER_STREET.WATSON, whose registered location will be the cluster name.

4. DFS> ADD ACCESS_POINT DEC:.LKG.S.DEPARTMENT_FINANCE -
_DFS> USER\$34:[000000] /LOCAL
DFS>

This command adds the access point to the local DECdfs server database. Note that the access point name includes the namespace name (DEC:). The access point refers to the directory USER\$34:[000000].

DISMOUNT

Renders a DECdfs client device unavailable to users.

Format

DISMOUNT *local-device-name*

Parameter

local-device-name

The name of the device to dismount. The value for *local-device-name* can be a logical name or the device name and unit number (DFSC*n*).

Description

This command renders a DECdfs client device unavailable to users. If the device was mounted with the /GROUP or /SYSTEM qualifier, you must have the user privilege GRPNAM or SYSNAM, respectively, to dismount it.

Before dismounting a client device, you can display a list of the client devices on your node (but not their logical names) by entering the DCL command SHOW DEVICE DFSC. Alternatively, you can use the DCL DISMOUNT command to dismount the device.

Qualifier

/ABORT

Cancels any outstanding I/O requests and terminates mount verification. This qualifier allows you to dismount a device regardless of who actually mounted it.

This qualifier is the same as the /ABORT qualifier to the DCL DISMOUNT command.

Example

```
DFS> DISMOUNT FINANCE
%DFS-S-DISMNT_SUCCESS, Dismount was successfully performed.
```

This command dismounts the local device whose logical name is FINANCE.

EXIT

EXIT

Terminates the current DFSS\$CONTROL session and returns the DCL prompt.

Format

EXIT

Parameters

None.

Description

Use the Exit command when you want to end the current DFSS\$CONTROL session and return to the DCL prompt.

Qualifiers

None.

Example

```
DFS> EXIT  
$
```

This command terminates the DFSS\$CONTROL session.

HELP

Displays help information on DFSSCONTROL commands.

Format

HELP [command-name]

Parameters

command-name

The command on which you want information.

Description

The HELP command displays information on DFSSCONTROL. If you include the *command-name* parameter, the HELP command displays information about that command. If you omit the *command-name* parameter, the HELP command displays a list of the topics for which information is available.

Qualifiers

None.

Example

```
DFS> HELP SHOW VERSIONS
```

This command displays version numbers for DECdfs software components.

When tracking down problems in communication between a DECdfs server and client, enter this command and compare the versions on the two nodes. Different versions of the DECdfs software might cause a number of errors. You also use this command to get version information required for reporting problems to Compaq.

Some version numbers are given as ranges, while others are single numbers. The range for the client protocol on the client node must overlap the server protocol on the server node. The communication protocol version must be the same on client and server.

This command displays information on the SHOW VERSIONS command.

MOUNT

MOUNT

Makes available a specified access point as a local DECdfs client device.

Format

```
MOUNT ap-name [local-logical-name]
```

Parameters

ap-name

Specifies an access point name on a DECdfs server. The name must already exist. That is, the server manager must have already registered it with the ADD ACCESS_POINT command.

local-logical-name

Designates a local logical name for the mounted device. The logical name is a string of 1 to 255 characters.

Description

This command allows your client system to use an access point located on a DECdfs server. When you mount an access point, DECdfs creates a pseudodevice of type DECdfs client (DFSC) on your system. The master file directory (MFD) for the mounted client device is the directory to which the access point refers. The device is mounted for sharing, as if you had used the DCL command MOUNT/SHARE.

The device name is DFSC*n*. If you do not use the /DEVICE qualifier, DECdfs assigns sequential unit numbers beginning with DFSC1001. DFS displays this name in the command response and instructs the communication entity to create a connection to the server. The connection is now ready to process user requests.

You can supply a local logical name for the access point. This lets subsequent DFS\$CONTROL and user commands see the device by that name. The *local-logical-name* parameter creates the logical name in the job logical name table. However, if you specify the /SYSTEM or /GROUP qualifier, the logical name is created in the system or group logical name table, respectively. Dismounting the device removes the logical name.

Attempts to mount an access point that is already mounted produce different results depending on whether the later mount command specifies /SYSTEM or /GROUP. If these qualifiers are specified, such an attempt fails with the message:

```
%MOUNT-VOLALRMNT, another volume of same label already mounted
```

If the mount attempt does not specify /SYSTEM or /GROUP, and no /DEVICE qualifier is specified, then a new DFSC device is created and the mount attempt proceeds. Thus, different users who mount the same access point will use different DFSC devices, but file access interlocking is not compromised because it always takes place at the server.

Most command qualifiers are the same as those for the DCL MOUNT command. Note that the command qualifiers apply to the client device on your system, not to the actual physical device at the server.

Qualifiers

/[NO]DATA_CHECK [=option]

Requests that the server perform a data check following all read requests, all write requests, or both read and write requests for the client device. The *option* value can be READ or WRITE or both.

The default qualifier is /NODATA_CHECK. If you specify /DATA_CHECK without an option, the default option is WRITE.

/DEVICE=DFSCn:

Specifies the DFSC unit on which the access point is to be mounted. If this qualifier is not supplied, the OpenVMS operating system automatically supplies the unit number starting at 1001. It is recommended that units numbered 1 to 1000 be reserved for system-mounted access points.

/GROUP

Makes the mounted client device and its logical name available to other users whose UIC group code matches yours. To use this qualifier, you must have the GRPNAM privilege. You cannot use the /GROUP and /SYSTEM qualifiers together.

/[NO]MESSAGE

Displays or suppresses the message that confirms a successful mount operation. The default qualifier is /MESSAGE.

/NODE=node_name

In systems without DECdns, specifies the node that serves an access point. In such systems, a MOUNT command entered without the /NODE qualifier cannot determine where the specified access point is located because the DECdns namespace is not available.

The MOUNT command does not prompt for the node name specification but if it is not supplied, the command will fail with the following error message:

```
%DFS-E-NODEMSNG, Server node not specified
```

Access point names are normally unique within the namespace. However, if DECdns is not used, there is no enforcement of uniqueness and the same access point name may be used on multiple nodes. This is recommended only for cluster nodes where the access point name refers to the same physical disk on all nodes. The MOUNT command expects access point names to be unique and does not implicitly qualify them with the node name. Therefore, an attempt to mount the same access point name on two different nodes is seen as an attempt to mount the same access point twice and is treated as described above.

/SYSTEM

Makes the mounted client device and its logical name available to every user on the system. To use this qualifier, you must have the SYSNAM privilege. You cannot use the /SYSTEM and /GROUP qualifiers together.

/VOLUME_NAME=string

Specifies a volume name of up to 12 characters for the client device. The volume name provides a way of identifying the device when you view the response to the DCL command SHOW DEVICE.

MOUNT

If you omit a volume name, the access point name is the default volume name if it has 12 or fewer characters. If the access point name has more than 12 characters, the default volume name consists of the first 5 characters of the access point name, 2 periods (.), and the last 5 characters of the access point name.

/WINDOWS=*n*

Specifies the number of mapping pointers to allocate for file windows. Extra window pointers are allocated automatically as required. For information on the range or default for the *n* value, see the *HP OpenVMS System Management Utilities Reference Manual*.

The DECdfs client device makes files appear to be contiguous even though they may not be contiguous at the server. Increasing this value, therefore, will not be useful for accessing fragmented files, as it would be with local file access. It might be useful, however, if you need to access very large files.

Example

```
DFS> MOUNT DEPARTMENT_FINANCE FINANCE
%MOUNT-I-MOUNTED, .DEPARTMENT_FINANCE mounted on _$DFSC1004:
```

This command mounts the access point DEPARTMENT_FINANCE, giving it the logical name FINANCE. The response indicates that DEPARTMENT_FINANCE was mounted on the local node as DECdfs client device DFSC1004:. The access point name conforms to conventions for a single-directory DECdns namespace.

REMOVE ACCESS_POINT

Removes a specified access point name from the DECdfs server database and from the Digital Distributed Name Service (DECdns) namespace.

Format

```
REMOVE ACCESS_POINT ap-name
```

Parameters

ap-name

Specifies the name of the access point to remove from the server database and from the DECdns namespace. If the server node does not have access to the DECdns namespace, or the server is not synchronized with the namespace, the access point must be fully qualified (namespace name and access point name).

Description

This command removes an access point name from both the server database and from the DECdns namespace. Entering this command does not affect operations on currently open files but does prevent new attempts to use the access point.

You must have the SYSNAM and OPER privileges to use this command.

Qualifiers

/LOCAL

Removes the access point from the local DECdfs server database. The access point name must include the namespace name unless you have defined the logical name DFSSDEFAULT_NAMESPACE in the DFSSCONFIG.COM file.

Examples

1. DFS> REMOVE ACCESS_POINT DEPARTMENT_FINANCE
DFS>

This command removes the access point DEPARTMENT_FINANCE from the DECdfs server and the DECdns namespace. In this example, the access point name is from a single-directory DECdns namespace.

2. DFS> REMOVE ACCESS_POINT BAKER_STREET.221B
DFS>

This command removes the DECdfs access point name 221B from the DECdns directory BAKER_STREET and the server database. In this example, the access point name is from a hierarchical DECdns directory.

3. DFS> REMOVE ACCESS_POINT DEC:.LKG.S.DEPARTMENT_FINANCE /LOCAL
DFS>

This command removes the access point from the local DECdfs server database. Note that the access point name includes the namespace name (DEC:).

SET COMMUNICATION

SET COMMUNICATION

Sets parameters for the DECdfs Communication Entity.

Format

SET COMMUNICATION

Parameters

None.

Description

This command sets Communication Entity parameters that affect file buffering, limits on use, lifetimes of DECnet logical links, message reporting, and data integrity checks.

These communication parameters can be dynamic or static. Dynamic parameters take effect when you enter the command; static parameters take effect the next time you start the communication entity. The description of each qualifier notes whether it takes effect on a dynamic or static basis.

You must have the OPER privilege to use this command.

Qualifiers

/BUFFER_SIZE=*n*

Sets the size (in bytes) of the DECdfs communication buffers for incoming and outgoing data. You need not set the same buffer size on client and server nodes; if the buffer sizes do not match, the DECnet software resolves the difference. The default buffer size is 2560 bytes; the range is from 560 to 9,216 bytes. If your system has enough memory, increasing the buffer size to 9,216 may improve DECdfs performance. This is a static parameter.

/[NO]CHECKSUM

Enables or disables DECdfs checksumming for all subsequent connections. You can enable and disable checksumming only from a client node; at a server-only node, this qualifier is ignored. If checksumming is enabled and DECdfs detects a checksum error at either the client node or the server node, it disconnects the DECnet link. Checksumming checks the data integrity above the DECnet level. The default qualifier is /NOCHECKSUM.

This qualifier takes effect only when a new DECnet logical link is created. DECdfs then starts checksumming for that and all subsequently created links. If a SHOW COMMUNICATION/CURRENT_CONNECTIONS command shows that at least one connection has a link status of Inactive, the next user request on that connection will create a new link and checksumming will start. If all connections have a link status of Active, checksumming will not start until all user file operations on one connection stop, two successive scan times expire, and a new user request creates a new link. If you must start checksumming immediately, you can use NCP or NCL commands to disconnect a link, as follows:

For DECnet Phase IV:

NCP> DISCONNECT LINK link-component

Replace *link-component* with the number of the link or, if you wish to disconnect all links, with the parameter KNOWN LINKS.

For DECnet Phase V:

NCL> DELETE SESSION CONTROL PORT session-control-port-name

A session control port represents one end of a transport connection (logical link). To determine which port to delete, use the command SHOW SESSION CONTROL PORT * ALL. The output from this command is as follows:

```
Node 0 Session Control Port SCL$PORT$12010015
at 1994-05-07-15:30:30.525-04:00I0.613

Identifiers
    Name                               = SCL$PORT$12010015

Status
    Client                             = <Default value>
    Local End User Address              = UIC = [0,0]<dfs$comacp>
    Transport Port                     = NSP Port NSP$PORT_00002016
    Direction                           = Outgoing
    Remote End User Address             = name = DFS$COM_ACP
    Node Name Sent                      = DEC:..ZKP.LAURAC
    Version Sent                        = V3

Counters
    Creation Time                       = 1994-05-07-15:29:18.476-04:00I0.568

Node 0 Session Control Port SCL$PORT$12010016
at 1994-05-07-15:30:30.525-04:00I0.613

Identifiers
    Name                               = SCL$PORT$12010016

Status
    Client                             = <Default value>
    Local End User Address              = name = DFS$COM_ACP
    Transport Port                     = NSP Port NSP$PORT_00002017
    Direction                           = Incoming
    Remote End User Address             = UIC = [0,0]<dfs$comacp>
    Node Name Sent                      = DEC:..ZKP.LAURAC
    Version Sent                        = V3

Counters
    Creation Time                       = 1994-05-07-15:29:18.626-04:00I0.568
```

The name of the session control port in this example is SCL\$PORT\$12010003. Note that the display identifies the session control port further by providing the name of the NSP port.

/READS_MAXIMUM=*n*

Sets the maximum number of concurrent read operations the Communication Entity can post to DECnet. Each read request requires one I/O request packet (called IRP in DECnet Phase IV and VCRP in DECnet Phase V) and one DECdfs communication buffer from nonpaged pool. The default value is 3; the range is from 1 to 20. This is a static parameter.

SET COMMUNICATION

/[NO]REPORTING [=option]

Enables or disables reporting of communication messages. DECdfs sends the reports that you enable to OPCOM as network class messages. Enable only the reports that you need, because the reports produce heavy output and can slow response time. This is a dynamic parameter. See Appendix B for more information on the /REPORTING qualifier, including a figure.

The *option* value can be one or more of the following:

ALL	Enables or disables all reports.
NONE	Disables all reports.
[NO]ERRORS	Enables or disables reporting of DECdfs Communication Entity errors.
[NO]NETWORK_EVENTS	Enables or disables reporting of DECnet events about the DECdfs Communication Entity.

The default reporting option is ALL. Do not use a double negative, such as /NOREPORTING=NONE.

/REQUESTS_OUTSTANDING_MAXIMUM=*n*

Specifies how many outstanding file I/O requests from clients a DECdfs server can have. The Communication Entity stops reading I/O from the network when outstanding requests exceed the specified maximum number. The default value is 20; the range is from 1 to 65,535. This is a dynamic parameter.

/SCAN_TIME=*time*

Specifies the time interval between scans for inactive DECnet links. If the Communication Entity finds an inactive link on two successive scans, it disconnects the link. The link is reestablished the next time a user on the client requests a file operation on the server. The default scan time is 4 minutes (00:04:00.00); the maximum is just under 24 hours (23:59:59.99). This is a dynamic parameter. The qualifier is valid only on the client.

Example

```
DFS> SET COMMUNICATION/NOREPORTING=NETWORK_EVENTS
DFS>
```

This command disables reporting of DECnet events about the DECdfs Communication Entity.

SET SERVER

Sets parameters for the DECdfs server.

Format

SET SERVER

Parameters

None.

Description

This command sets server parameters that affect the creation of access points, the caching of file blocks, the caching of user access rights information, and the type of message reporting to use.

These server parameters can be dynamic or static. Dynamic parameters take effect when you enter the command; static parameters take effect the next time you start the server unless described otherwise below. The description of each qualifier notes whether the parameter is dynamic or static.

You must have the OPER privilege to use this command.

Qualifiers

/ACCESS_POINTS_MAXIMUM=*n*

Sets the maximum number of access points in the server's database. The default value is 128; the range is from 64 to 65,535. This is a static parameter that takes effect when you enter the next START SERVER command.

/DATA_CACHE=*option*

Sets values for the server's data cache. This is a static parameter. It takes effect the next time you *reboot* and restart DFS.

The *option* value can be one or both of the following:

COUNT_OF_BUFFERS=*n* Allocates *n* buffers from nonpaged pool for use in DECdfs file data caching. Each buffer takes a total of 8242 bytes. The default *n* value is 16; the range is from 16 to 2048.

FILE_BUFFER_QUOTA=*n* Specifies how many cache buffers a single file usually uses. The default quota is 4; the range is from 2 to 512.

For normal use, insert the COUNT_OF_BUFFERS and FILE_BUFFER_QUOTA values into the DFSSCONFIG.COM command procedure.

/INVALIDATE_PERSONA_CACHE

Immediately flushes the persona cache and closes and reopens the NETPROXY.DAT file.

SET SERVER

/PERSONA_CACHE=UPDATE_INTERVAL=*time*

Sets the lifetime of individual persona blocks for the server's persona cache. If a user whose persona block is outdated attempts a file access, the DECdfs server reads the NETPROXY.DAT, SYSUAF.DAT, and RIGHTS.LIST.DAT files and updates the persona cache with that information. The default interval is 10 minutes (00:10:00.00); the maximum is just under 24 hours (23:59:59.99). This is a dynamic parameter.

/[NO]REPORTING [=option]

Enables or disables reporting of server messages. Output goes to the log files specified with the START SERVER command's /ERROR and /OUTPUT qualifiers. This is a dynamic parameter.

The *option* value can be one or both of the following:

[NO]ERRORS	Enables or disables reporting of DECdfs server general errors.
[NO]OPCOM	Enables or disables reporting of any events as network class messages to OPCOM. The default is OPCOM.

Examples

1. DFS> SET SERVER/ACCESS_POINTS_MAXIMUM=30
DFS>

This command sets the access point limit for a DECdfs server to 30.

2. DFS> SET SERVER/DATA_CACHE=(COUNT_OF_BUFFERS=17, -
_DFS> FILE_BUFFER_QUOTA=5)
DFS>

This command sets two values for the server's data cache: the number of buffers in the cache, and the per-file buffer quota. The command concatenates the two /DATA_CACHE qualifier options by surrounding them in parentheses and separating them with a comma.

SHOW ACCESS_POINT

Displays access points stored by the Digital Distributed Name Service (DECdns) and by individual DECdfs server databases.

Format

```
SHOW ACCESS_POINT ap-name
```

Parameter

ap-name

Specifies the access point name to display.

If the DECdns namespace is a single-directory namespace, an asterisk (*) wildcard character operates as it does in DCL file specifications: it expands to the names of all access points. A question mark (?) in DECdfs operates as a percent sign (%) operates in DCL. The question mark expands to the names of access points that match in all characters except the one represented by the wildcard.

With a hierarchical DECdns namespace, an asterisk (*) wildcard character in the last segment of the name displays all access point names in the DECdns directory named by the previous segment. If the first segment is a logical name (defined in DNS\$SYSTEM_TABLE), DECdns translates it and then adds the information that follows to the end of the equivalence string. If you want to prevent this translation, put a period (.) before the first segment.

Description

This command displays a list of access points and their node locations as registered with DECdns.

The default qualifiers are /BRIEF and /REMOTE.

Qualifiers

/BRIEF

Shortens and quickens the command response by including just the DECdns information (access point name and node name) and omitting the server information (device and directory) and namespace name. The default qualifier is /BRIEF.

/FULL

Displays the following information for each access point:

- The full name, starting with the namespace name
- The node on which the server is located
- The device and directory to which the access point refers
- Status information on the availability of the server or the access point (when necessary)

The /FULL qualifier causes DECdfs to verify the DECdns information by querying each server for current information about the access points. The server information includes the device and directory to which the access point refers or gives current status information. For example, the command response might tell you that the server is currently unavailable or that the access point

SHOW ACCESS_POINT

is not being served. The /FULL qualifier also adds the namespace name to each displayed access point name. Querying each remote server causes a slower command response with the /FULL qualifier.

Querying a remote server for information on access points and displaying that information at your node creates a DECdfs connection between your node and that server node. You sometimes see those connections in the response to a SHOW COMMUNICATION command.

/LOCAL

Lists the access points in the local server database. /LOCAL is the default on systems without DECdns. You can use wildcard characters for any part of the access point name or for the entire name. You cannot use the /LOCAL qualifier with other qualifiers except /FULL.

/NODE=node-name

Lists the access points located on just the specified node. The /NODE qualifier is valid only on systems that are running DECdns.

/REMOTE

Lists the access points on remote nodes only. The /REMOTE qualifier is the default on systems running DECdns.

Examples

1. DFS> SHOW ACCESS_POINT/LOCAL
DEC:.LKG.S.DEPARTMENT_FINANCE on SCOTER::USER\$34:[000000]

This command displays information about the access point DEPARTMENT_FINANCE, including the full namespace name. The command output shows that the access point refers to the master file directory of device USER\$34.

2. DFS> SHOW ACCESS_POINT FIN.ADMIN.DIV.MYSTRY*
FIN.ADMIN.DIV.MYSTRY on SCOTER::
FIN.ADMIN.DIV.MYSTRY\$VMS_SOURCE on SCOTER::
FIN.ADMIN.DIV.MYSTRY_DUA0 on SCOTER::
FIN.ADMIN.DIV.MYSTRY_USER on SCOTER::
FIN.ADMIN.DIV.MYSTRY_VMS_SOURCE on SCOTER::

This command illustrates the default brief display of access point names. It also illustrates how you can use a wildcard in the command with a hierarchical namespace. The display includes just the names of the access points and their server nodes.

3. DFS> SHOW ACCESS_POINT FIN.MYSTRY*/FULL
CRANE_NS:.FIN.MYSTRY on SCOTER:: Access point is not presently being served
CRANE_NS:.FIN.MYSTRY_DUA0 on JAY:: Server is presently unavailable
CRANE_NS:.FIN.MYSTRY_USER on SCOTER::USER\$1:[000000]
CRANE_NS:.FIN.MYSTRY_VMS_SOURCE on WARBLR::DUA0:[VMS_SOURCE]

This command illustrates a full display of access point names in the directory FIN.MYSTRY, which is part of the hierarchical namespace CRANE_NS. For each access point, the display includes the namespace name, the name, the server node name, and, when available, the device and directory.

SHOW ACCESS_POINT

Full information is not available for all of the access points in this display. One access point “is not presently being served.” This indicates that the DECdns namespace contains an entry for the access point but the DECdfs server does not. For another access point, the “Server is presently unavailable.” This indicates that the server on that node has stopped, and it is therefore not processing requests for information.

SHOW CLIENT

SHOW CLIENT

Displays information about a DECdfs client device.

Format

SHOW CLIENT *local-device-name*

Parameter

local-device-name

Specifies a local DECdfs client device. The value for *local-device-name* can be either a logical name that you assigned or the pseudodevice name that OpenVMS assigned (DFSC*n*).

Description

For the device name that you specify, this command displays the name of its associated access point and access point's server node. You can also display the client counters.

If the device that you specify is unavailable (not mounted), the command returns an error message.

Qualifiers

/ACCESS_POINT

Displays the name of the access point associated with the specified device.

/ALL

Displays all client parameters and counters.

/[NO]COUNTERS

Displays or suppresses information about the following DECdfs client counters: file operations performed, bytes read from the device, bytes written to the device, files opened by the device, and mount verifications tried.

The client counters reflect use from the time that you mounted the client device. They wrap when they exceed the maximum value of 64 bits (32 bits for the number of file operations). The display includes two sets of values: the current values, and the difference between the current values and those recorded by the last SNAPSHOT CLIENT command.

/FREE_BLOCKS

Displays the number of free blocks currently available on the client device.

/NODE

Displays the name of the DECdfs server node to which the client device gives access.

/SNAPSHOT_FILE=*file-spec*

Specifies the file to which you previously sent a client snapshot (using the SNAPSHOT CLIENT/SNAPSHOT_FILE=*file-spec* command). The output for this command compares the current counters with the counters recorded in that file. You can use this qualifier with the /COUNTERS qualifier.

Examples

- DFS> **SHOW CLIENT DFSC1001**
 Client Device DFSC1001 (Translates to _DFSC1001:)
 Status = Available
 Access Point = DEC:.LKG.S.TANTS.RANGER_SATURN
 Node = RAINBO
 Free blocks = 61518

This command displays all information on the client device represented by the name dfsc1001. The command output shows that the mounted device is available and is associated with the access point DEC:.LKG.S.TANTS.RANGER_SATURN on node RAINBO.

- DFS> **SHOW CLIENT DFS\$DISK/COUNTERS**
 Client Device DFS\$DISK (Translates to _DFSC1:)
 DECdfsClient Counters (Snapshot from Startup)

Counter	Current Value	Change Since Snapshot
Operations Performed	8090	8090
Bytes Read	4203520	4203520
+ Bytes Written	+ 189440	+ 189440
Files Opened	796	796
Mount Verifications Tried	0	0

This is an example of the client counters display. Note that the display includes the actual device name for the logical device specified in the command. This command response shows that DECdfs compared the current counters with the initial zero values, since the current values and the “Change Since Snapshot” values are the same.

SHOW COMMUNICATION

SHOW COMMUNICATION

Displays information on the DECdfs Communication Entity.

Format

SHOW COMMUNICATION

Parameters

None.

Description

This command displays a variety of Communication Entity values and, optionally, counters.

Note that a previous SET COMMUNICATION command might have set some (static) communication values that will not take effect until you next restart DECdfs. In this instance, this command displays both the current (most recently set) value and the static value now in use.

Each qualifier is described in more detail in the SET COMMUNICATION command description.

Qualifiers

/ALL

Displays all communication qualifier values and counters.

/BUFFER_SIZE

Displays the message buffer size of the DECdfs Communication Entity.

/CHECKSUM

On a client node, displays whether DECdfs is performing checksumming.

/[NO]COUNTERS

Displays or suppresses information about the following DECdfs communication counters: bytes sent and received, bytes lost because of checksum errors, number of checksum errors, and communication errors. Communication errors are those that the DECnet network passes up to the Communication Entity, such as "Network partner task aborted the logical link," "Path to the network partner task node was lost," and so forth.

The display includes two sets of values: the current values, and the difference between the current values and those recorded by the last SNAPSHOT COMMUNICATION command. To use a particular snapshot file for the comparison, use this qualifier with the /SNAPSHOT_FILE qualifier.

/CURRENT_CONNECTIONS

Lists the current connections maintained by the Communication Entity. The command output displays the following information about each connection:

SHOW COMMUNICATION

- The name of the remote server node (for any outbound connections) or the remote client node (for any inbound connections). If the node name is a cluster alias, the cluster member name appears in parentheses.
- The type of connection (inbound or outbound).
- The state of the connection's DECnet logical link (active if DECdfs is currently using the link, inactive if DECdfs disconnected the link after the expiration of two successive scans).
- The state of checksumming (enabled or disabled).
- The number of active sessions (the number of open files).

In examining the command response, note that some inbound connections might occur because remote DECdfs users are displaying access point information, and not necessarily because remote users are performing file operations.

/READS_MAXIMUM

Displays the current number of concurrent read operations the Communication Entity can post to DECnet.

/REQUESTS_OUTSTANDING_MAXIMUM

Displays the number of outstanding I/O requests a node can have.

/REPORTING

Displays the status of communication reporting to OPCOM.

/SCAN_TIME

Displays the interval between scans for inactive DECnet links.

/SNAPSHOT_FILE=*file-spec*

Specifies the file to which you previously sent a communication snapshot (using the `SNAPSHOT COMMUNICATION/SNAPSHOT_FILE=file-spec` command).

The output for this command compares the current counters with the counters recorded in that file. Use this qualifier with the `/COUNTERS` qualifier.

/STATUS

Displays the status of the DECdfs Communication Entity, as follows:

Running	Ready to process or is currently processing requests.
Shutdown	Responding to a SHUTDOWN COMMUNICATION command; that is, allowing existing file operations to complete but denying new requests.
Stopped	Stopped because of completion of shutdown status, response to a STOP COMMUNICATION command, or an unexpected error.

SHOW COMMUNICATION

Examples

1. DFS> SHOW COMMUNICATION/ALL/NOCOUNTERS

Parameter	Current Value	Minimum Allowed	Maximum Allowed	Static Value
Communication Status	Running			
Buffer Size	2560	560	65516	2560
Req. Outstanding Max.	20	1	65535	
Reads Maximum	3	1	10	3
Scan Time	00:04:00.00	00:00:00.00	23:59:59.99	
Report Errors	Disabled			
Report Network Events	Disabled			
Checksum	Disabled			

This command displays the Communication Entity parameters. Note that, when appropriate, the display includes the range of values for the parameter.

2. DFS>SHOW COMMUNICATION/COUNTERS/SNAPSHOT FILE=COMM_SNAP.DAT
Communication Counters (Snapshot from 8-JAN-1999 08:31:18.22)
Snapshot interval is 0 00:01:59.43
Snapshot file = COMM_SNAP.DAT

Counter	Current Value	Change Since Snapshot
Bytes Sent	2248815	54689
Bytes Received	7220040	299510
Bytes Lost from Checksum Errors	0	0
+ Number of Checksum Errors	+ 0	+ 0
Communication Errors	0	0

This command displays the current communication counters and compares them with the counters in the file COMM_SNAP.DAT.

3. DFS> SHOW COMMUNICATION/CURRENT_CONNECTIONS

DFS/COM Connections at 08-JAN-1999 08:33:36.69

Node	Type	Link State	Checksum	Active Sessions
LINNET (CHICKN)	Inbound	Inactive	Disabled	0
VIREO	Inbound	Inactive	Disabled	0
PLOVER	Outbound	Active	Disabled	0
THRUSH	Outbound	Active	Disabled	0
SNIPE	Outbound	Inactive	Disabled	0
ROBIN	Outbound	Inactive	Disabled	0
VIREO	Outbound	Inactive	Disabled	0
PIPER	Outbound	Inactive	Disabled	0
HERON	Outbound	Inactive	Disabled	0

This command displays information about the Communication Entity's current connections. In this example, the node has both a DECdfs server and a DECdfs client. For the server on this node, the Communication Entity handled one or more requests from a client on node VIREO. The node name LINNET is a cluster alias. The following line (CHICKN) indicates that the cluster member CHICKN is the node handling the connection.

SHOW SERVER

Displays information on the DECdfs server.

Format

SHOW SERVER

Parameters

None.

Description

This command displays a variety of server parameters and, optionally, counters.

Note that a previous SET SERVER command might have set some (static) server parameters that will not take effect until the next START SERVER command. For such parameters, this command displays two values: the current (most recently set) value and the static value now in use.

For more information on each server parameter, see the SET SERVER command description.

The default qualifiers are /ALL and /NOCOUNTERS.

Qualifiers

/ACCESS_POINTS_MAXIMUM

Displays the maximum number of access points that can be stored in the DECdfs server database.

/ACTIVE_FILES

For each file currently open for a DECdfs end user, displays the file specification and the name of the user.

/ALL

Displays all server parameters and counters. For each parameter, the display includes the current value, the minimum and maximum allowed values, and the static value. The current and static values might be different for static parameters.

To display all server parameters without the counters, use the /ALL and /NOCOUNTERS qualifiers.

/[NO]COUNTERS

Displays all DECdfs server counters. The display includes two sets of values: the current values, and the difference between the current values and those recorded by your last SNAPSHOT SERVER command. To use a particular snapshot file for the comparison, use the /SNAPSHOT_FILE=*file-spec* qualifier. The counters wrap when they reach their maximum value (64 bits). For a description of the persona cache counters, see Section 2.6.3. For a description of the data cache counters, see Section 2.7.3

SHOW SERVER

/DATA_CACHE [=option]

Displays information about the data cache. The *option* value can be one or both of the following:

FILE_BUFFER_QUOTA Displays the per-file quota for data cache buffers.
COUNT_OF_BUFFERS Displays how many cache buffers a single file usually uses.

/PERSONA_CACHE=UPDATE_INTERVAL

Displays the lifetime of individual blocks in the persona cache.

/REPORTING

Displays the status of server message reporting.

/SNAPSHOT_FILE=file-spec

Specifies the file to which you previously sent a server snapshot (using the SNAPSHOT SERVER/SNAPSHOT_FILE=file-spec command). The output for this command compares the current counters with the counters recorded in that file. Use this qualifier with the /COUNTERS qualifier.

/STATUS

Displays the status of the DECdfs server, as follows:

Running Ready to process or currently processing requests.
Stopped Stopped in response to a STOP SERVER command.
Aborted Stopped because of an unexpected error.

/USERS

Displays information on client users that have recently accessed the server. The display contains information from the persona cache and includes the user name, node name, and proxy account name.

The display also shows the number of open files and the status of the persona block. Expired persona blocks are marked QUOTE(Inval). (See the SET SERVER /PERSONA_CACHE=UPDATE_INTERVAL command.) These blocks appear in the display if any currently open files are using them or if recently closed files were using them. When a client user of an invalid persona block has new activity, the server builds a new persona block.

Examples

1. DFS> SHOW SERVER/ALL/NOCOUNTERS

Parameter	Most Recent Setting	Minimum Allowed	Maximum Allowed	Static Value
Server Status	Running			
Access Points Maximum	128	64	65535	128
Report Errors	Disabled			
Report OPCOM Events	Disabled			
D. Cache Buffer Count	16	16	512	16
D. Cache Quota	4	1	64	
P. Cache Update Intrvl	00:10:00.00	00:00:00.00	23:59:59.99	

This command displays all the DECdfs server parameters. Note that the display includes the minimum and maximum allowed values for each.

SHOW SERVER

2. DFS> SHOW SERVER/COUNTERS

```
DECdfs Server Counters (Snapshot from 10:38:16.01)
Snapshot interval is 0 00:00:44.76
```

Counter	Current Value	Change Since Snapshot
P. Cache Blocks Active	4	0
Maximum P. Cache Blocks Active	7	
+ P. Cache Blocks Allocated	+ 30	+ 0
Max. P. Cache Blocks Allocated	30	
P. Cache Hits	796483	91
+ P. Cache Misses	+ 1366	+ 0
D. Cache Full	0	0
D. Cache Hits	55656	8
+ D. Cache Misses	+ 441831	+ 47
D. Cache Quota Exceeded	113	0
RMS Directory Opens	0	0
+ Physical Reads	+ 191477	+ 17
Physical Writes	3770013	469

This command displays current server counters and compares them with counters recorded at the time of the last snapshot. The example shows a high ratio of persona cache hits to misses, indicating that the persona cache update interval is set high enough.

3. DFS> SHOW SERVER/USERS

```
4 DECdfs Users at 08-JAN-1999 08:35:20.50
```

Remote User	Local User	Files Open	Persona Block
JULIE::CORENZWIT	DFS_JAC	0	Inval
LAURAP::CORENZWIT	CORENZWIT	0	Valid
QUANTZ::CORENZWIT	DFS_JAC	1	Valid
LAURAP::CORENZWIT	CORENZWIT	1	Inval

This command displays the users that have current or recent activity on the server. Note that the command display shows only two users with open files: QUANTZ::CORENZWIT and LAURAP::CORENZWIT. LAURAP::CORENZWIT has an open file that is using a persona block that expired after the file was opened. After the persona block expired, LAURAP::CORENZWIT opened and closed another file, causing the building of another persona block. If you see apparent duplicate entries in this display, you should expect to see only one valid entry for any one client user.

JULIE::CORENZWIT also has an invalid entry in the display but has no files open. This can happen when a user keeps a file open for a longer period of time than the persona cache update interval and the display appears shortly after that user closes the file. User entries can appear in the display for about five to ten minutes after their last activity.

4. DFS> SHOW SERVER/ACTIVE_FILES

```
3 DECdfs Server Open Files at 08-JAN-1999 08:34:35.94
```

Remote User	File
FALCON::PFC	DISK\$VAXVMSRL4: [USER.CODWELL] LOGIN.COM;4
FALCON::PFC	DISK\$VAXVMSRL4: [USER.CODWELL] ERRNO.MSG;1
RAVEN::WICKLES	DISK\$VAXVMSRL4: [CDC_SOURCE] RDERR.LOG;1

This command shows that user PFC on node FALCON is currently accessing

SHOW SERVER

two files: LOGIN.COM and ERRNO.MSG. User WICKLES on node RAVEN is currently accessing the file RDERR.LOG.

SHOW VERSIONS

Displays version information for DECdfs components.

Format

SHOW VERSIONS

Parameters

None.

Description

This command displays version numbers for DECdfs software components. Use this command to get version information required for reporting problems to Compaq.

When you view the response to this command, note that the range for the client protocol on the client node must overlap with the range for the server protocol on the server node. Otherwise, the client and server cannot interoperate. The communication protocol is not a range; it must be the same on both the client and server.

Qualifiers

None.

Example

```
DFS> SHOW VERSIONS
Component          | Version   | Time Started
-----+-----+-----+
Communication Entity | V2.3-0   | 23-OCT-1998 13:56:26.61
Communication Protocol | 1.0-0   |
Server Entity      | V2.3-0   | 23-OCT-1998 13:56:28.96
Server Protocol    | 1.0 - 1.5 |
Client Entity      | V2.3-0   |
Client Protocol    | 1.0 - 1.5 |
DFS Control Program | V2.3-0   |
-----+-----+-----+
```

This command displays the version numbers of DECdfs components.

SHUTDOWN COMMUNICATION

SHUTDOWN COMMUNICATION

Stops DECdfs communication after existing file operations are complete.

Format

SHUTDOWN COMMUNICATION

Parameters

None.

Description

This command initiates a controlled shutdown of communication. It denies requests for new connections and waits for open files to be closed before stopping the Communication Entity. Entering the SHOW COMMUNICATION command displays the state of the Communication Entity, which is first "Shutdown" and then "Stopped." When the Communication Entity stops, it disconnects all DECnet links. To restart the entity, you should execute the SYS\$STARTUP:DFS\$STARTUP.COM file. In contrast, the STOP COMMUNICATION command aborts existing connections. Use SHUTDOWN COMMUNICATION whenever possible.

On a server, executing the SHUTDOWN COMMUNICATION command also stops the server when the Communication Entity stops.

You must have the CMKRNL and WORLD or GROUP privileges to use this command.

Qualifiers

None.

Example

```
DFS> SHUTDOWN COMMUNICATION
DFS>
```

This command causes the Communication Entity to refuse new requests and then to stop communication when all open files are closed.

SNAPSHOT CLIENT

Records the current DECdfs client counters for the specified client device.

Format

SNAPSHOT CLIENT *local-device-name*

Parameter

local-device-name

Specifies the client device to record in the snapshot.

Description

This command records the current client counters for later use in client tuning or troubleshooting. After entering the SNAPSHOT command, you can enter the SHOW CLIENT/COUNTERS command. The display will compare the current counters with the counters preserved by the SNAPSHOT command.

The information that you record with the SNAPSHOT command is usually stored in DFSSCONTROL memory. For a more permanent record, use the /SNAPSHOT_FILE qualifier.

Qualifier

/SNAPSHOT_FILE=file-spec

Writes the current counter values to the specified file instead of to DFSSCONTROL memory. You cannot display this file using DCL commands such as TYPE; display the information in it by entering the SHOW CLIENT/SNAPSHOT_FILE=*file-spec* command.

Example

```
DFS> SNAPSHOT CLIENT DFSDISK/SNAPSHOT_FILE=DFSDISK:[LFS]SNAP_CLI.DAT
DFS> SHOW CLIENT DFSDISK/COUNTERS/SNAPSHOT_FILE=DFSDISK:-
_DFS> [LFS]SNAP_CLI.DAT
```

```

Client Device DFSDISK (Translates to _DFSC1:)
DECdfs Client Counters (Snapshot from 11:18:56.78)
Snapshot interval is 0 00:00:27.12

```

Counter	Current Value	Change Since Snapshot
Operations Performed	72956	6
Bytes Read	24786944	0
+ Bytes Written	+ 1931776	+ 1024
Files Opened	7366	1
Mount Verifications Tried	0	0

This example shows a sequence of commands. The first command records the client counters and writes them to the file SNAP_CLI.DAT. The SHOW CLIENT command then displays the current counters and compares them with the counters in the snapshot file.

SNAPSHOT COMMUNICATION

SNAPSHOT COMMUNICATION

Records the current DECdfs communication counters.

Format

SNAPSHOT COMMUNICATION

Parameters

None.

Description

This command records the current communication counters for later use in tuning or troubleshooting. After entering this SNAPSHOT command, you can enter the SHOW COMMUNICATION/COUNTERS command. The display will compare the current counters with the counters preserved by the SNAPSHOT command.

The information that you record with the SNAPSHOT command is usually stored in DFSS\$CONTROL memory. For a more permanent record, use the /SNAPSHOT_FILE qualifier.

Qualifier

/SNAPSHOT_FILE=file-spec

Directs DFSS\$CONTROL to save the current counter values in the specified file instead of in DFSS\$CONTROL memory. You cannot display this file using DCL commands such as TYPE; display the information in it by entering the SHOW COMMUNICATION/SNAPSHOT_FILE=*file-spec* command.

Example

```
DFS> SNAPSHOT COMMUNICATION/SNAPSHOT_FILE=COMM_SNAP.DAT
DFS>
```

This command records the current communication counters, writing them to the file COMM_SNAP.DAT. The SHOW COMMUNICATION/SNAPSHOT=*file-spec* command then displays the current counters and compares them with the counters in the snapshot file.

SNAPSHOT SERVER

Records the current DECdfs server counters.

Format

SNAPSHOT SERVER

Parameters

None.

Description

This command records the current server counters for later use in tuning or troubleshooting. After entering the SNAPSHOT command, you can enter the SHOW SERVER/COUNTERS command. The resulting display compares the current counters with the counters preserved by the SNAPSHOT command.

The information that you record with the SNAPSHOT command is usually stored in DFSS\$CONTROL memory. For a more permanent record, use the /SNAPSHOT_FILE qualifier.

Qualifier

/SNAPSHOT_FILE=*file-spec*

Writes the current counter values to the specified file instead of DFSS\$CONTROL memory. You cannot display this file using DCL commands like TYPE; display the information in it by entering the SHOW SERVER/SNAPSHOT_FILE=*file-spec* command.

Example

```
DFS> SNAPSHOT SERVER/SNAPSHOT_FILE=SERVER_SNAPSHOT.DAT
DFS>
```

This command records the current server counters in the file SERVER_SNAPSHOT.DAT. You can then use the SHOW SERVER/SNAPSHOT=*file-spec* command to display the current counters and compare them with the counters in the snapshot file.

START COMMUNICATION

START COMMUNICATION

Starts the DECdfs Communication Entity.

Format

START COMMUNICATION [*comm-file-spec*]

Parameter

comm-file-spec

Specifies a DECdfs communication ancillary control process (ACP) that differs from the default file specification, which is SYSS\$SYSTEM:DFS\$COM_ACP.EXE.

Description

This command starts executing the Communication Entity ACP, making it available for use by clients, or servers or both, and setting its counters to zero.

You usually enter this command from the DFS\$STARTUP file. However, you can also enter it interactively to restart the Communication Entity after a STOP COMMUNICATION command or an unexpected abort.

You must have CMKRNL and PSWAPM privileges to use this command.

Qualifiers

/ERROR=file-spec

Specifies the output destination to use for DECdfs communication ACP errors. The default destination is the log file.

/OUTPUT=file-spec

Specifies the destination for communication ACP output. The default destination is SYSS\$MANAGER:DFS\$ERROR.LOG

Note

Only certain errors that can occur during communication startup go to the destinations that the */ERROR* and */OUTPUT* qualifiers specify. All other communication errors go to OPCOM.

Example

```
DFS> START COMMUNICATION
DFS>
```

This command starts the DECdfs Communication Entity.

START SERVER

Starts the DECdfs server.

Format

```
START SERVER [server-file-spec]
```

Parameter

server-file-spec

Specifies a DECdfs server ancillary control process (ACP) that differs from the default file specification, which is SYSS\$SYSTEM:DFSS\$SERVER_ACP.EXE.

Description

This command starts executing the server ACP, making the server available for incoming client requests, and setting its counters to zero.

You usually enter this command from the DFSS\$STARTUP file. However, you can also enter it interactively to restart the server after a STOP SERVER command or an unexpected abort.

You must have CMKRNL, PSWAPM, OPER, and PHY_IO privileges to use this command.

Qualifiers

/ERROR=file-spec

Specifies an output destination for the error messages from the DECdfs server ACP that differs from the default file specification, which is SYSS\$MANAGER:DFSS\$ERROR.LOG.

/OUTPUT=file-spec

Specifies an output destination for the OPCOM messages from the DECdfs server ACP that differs from the default file specification, which is SYSS\$MANAGER:DFSS\$ERROR.LOG.

Example

```
DFS> START SERVER/ERROR=SYSS$MANAGER:DFSS$MESSAGE.LOG  
DFS>
```

This command starts the server and specifies that DECdfs writes error messages to the file SYSS\$MANAGER:DFSS\$MESSAGE.LOG.

STOP COMMUNICATION

STOP COMMUNICATION

Stops the DECdfs Communication Entity immediately, aborting existing connections.

Format

STOP COMMUNICATION

Parameters

None.

Description

This command immediately stops the Communication Entity ancillary control process (ACP) from executing. This disconnects DECnet links and aborts all incoming and outgoing communication. To restart the entity, you should execute the SYS\$STARTUP:DFSS\$STARTUP.COM file.

On a server, executing this command also stops the server, as if you had entered the STOP SERVER command.

On a client, end users currently using DECdfs to access files get the SSS_ABORT error. The client then gives the Communication Entity several chances to restart. It tries to reestablish its relationship with the Communication Entity for a short time, while reporting a "Mount verification in progress" message to OPCOM. Unless you start the Communication Entity again during this period, the mount verification times out. End users who attempt a new file operation then get a "Device not ready, not mounted, or unavailable" message.

In contrast, the SHUTDOWN COMMUNICATION command initiates a controlled shutting down of services and does not abort user operations. Use the SHUTDOWN COMMUNICATION command whenever possible.

You must have the CMKRNL and WORLD or GROUP privileges to use this command.

Qualifiers

None.

Example

```
DFS> STOP COMMUNICATION
DFS>
```

This command immediately stops the DECdfs Communication Entity.

STOP SERVER

Stops the DECdfs server immediately.

Format

STOP SERVER

Parameters

None.

Description

This command stops the local DECdfs server process, making local access points unavailable to client users and closing open files on the server. The end user might not know immediately that the file is closed on the server, depending on the application being used. However, the user's next I/O request to the client device will return a "Device offline" error message.

You must have the CMKRNL, PHY_IO, and OPER privileges to use this command.

Qualifiers

None.

Example

```
DFS> STOP SERVER  
DFS>
```

This command stops the DECdfs server process and closes open files.

Status Messages

This appendix lists and explains the messages issued by DECdfs for OpenVMS. Messages of all severity levels are merged together in alphabetical order. You can also view these messages using the Help Message utility. For more information on using this utility, refer to the *OpenVMS System Messages: Companion Guide for Help Message Users*.

In this appendix, there are two common suggested user actions:

- Verify that the DECnet software is operational.
- Verify the DECdfs installation.

To verify that the DECnet software is operational, check the executor state and then view the executor, line, and circuit counters. For information on network troubleshooting, refer to the following manuals:

For DECnet Phase IV:

- *DECnet for OpenVMS Network Management Utilities*

For DECnet Phase V:

- <REFERENCE>(DNPLUS_NCL_REF)
- *DECnet/OSI Network Control Language Reference*
- *DECnet/OSI Network Management*

To verify the DECdfs installation, make sure that the system and network parameters have been modified according to the suggestions in this manual and the installation guide. Also, examine the DECdfs command files to make sure they have been edited properly.

If you receive DECdns errors, consult with your DECdns manager.

If you need to report a DECdfs software problem, see the <REFERENCE>(DFS_inst_guide) for information on reporting problems.

ACCESS, Failure accessing kernel device

Explanation: An error occurred during initialization of the server process. This message has a severity level of Error.

User Action: One possible cause of this problem is that the Communication Entity is not currently running. Verify that it is running by using the DECdfs command SHOW COMMUNICATIONS from within the DFSS\$CONTROL utility. Also verify the DECdfs installation (as described in the installation guide). If the problem persists, report it.

Status Messages

ACCPNTMAX_RANGE, The value given for the access point maximum is out of range

Explanation: The specified value for the maximum number of access points on the server is outside the valid range. This message has a severity level of Error.

User Action: Repeat the operation, using an appropriate value. To display the range of correct values, use the DFSSCONTROL command SHOW SERVER/ACCESS_POINTS_MAXIMUM.

ACCPNT_CONFLICT, Access point exists for different device or directory.

Explanation: An access point of the same name has already been added on this node, but it is a different device or directory. This message has a severity level of Error.

User Action: Choose a different access point name or remove and re-add the access point. The DFSSCONTROL command SHOW ACCESS_POINT /LOCAL displays the device and directory information for the access point.

ACCPNTNM, Quoted access point names are illegal.

Explanation: You cannot surround an access point name with quotation marks. This message has a severity level of Error.

User Action: Enter the ADD ACCESS_POINT command again, but do not use quotation marks. Access point names can consist of alphanumeric characters and underscores. A name in a hierarchical namespace can also contain period (.) characters. The dollar sign (\$) is reserved for use by Compaq.

ADDELE, Error formatting element

Explanation: An internal error occurred on the server. This message has a severity level of Warning.

User Action: Verify that the server is properly installed (as described in the installation guide). If the problem persists, report it.

ADDFUNC, Error formatting function identifier in server

Explanation: An internal error occurred on the server. This message has a severity level of Warning.

User Action: Verify that the server is properly installed (as described in the installation guide). If the problem persists, report it.

AGENTABRT, DFS/COM service agent aborted session

Explanation: The DECdfs server unexpectedly terminated communication. This message has a severity level of Error.

User Action: Verify that DECnet and the DECdfs server are operational. If they are, retry the operation. If the problem persists, report it.

ALIAS_REMOVE, Cluster alias access point name removed from DNS server and from DFS server on this node

Explanation: An access point name that was added (with the DFSSCONTROL command ADD /CLUSTER_ALIAS) has been removed from the Distributed Name Service and from the local DECdfs server access point database on this node. This message has a severity level of Information.

User Action: You should remove the access point from the local server access point databases on any other cluster members that had the access point

name added (with the DFSSCONTROL command ADD /CLUSTER_ALIAS) or you should disable incoming alias on this node. To remove the access point from other cluster members, use the DFSSCONTROL command SHOW ACCESS_POINT /LOCAL /FULL. Then use the DFSSCONTROL command REMOVE ACCESS_POINT on each of the other nodes serving the access point. Use the fully expanded access point name as displayed by the SHOW command.

ALLOCFDB, Server unable to allocate file descriptor block

Explanation: An error occurred during the server's initial access of a file. The server was unable to obtain the necessary memory resources. This message has a severity level of Error.

User Action: Verify that the server is properly installed (as described in the installation guide). Check the setting for the SYSGEN parameter NPAGEDYN. If the problem persists, report the problem.

ALLOCSTK, Failure allocating special kernel stack

Explanation: There is not enough virtual memory to initialize a new server process. This message has a severity level of Error.

User Action: See the additional message that follows. Verify that the server is properly installed (as described in the installation guide). If the problem persists, report it.

APTFULL, Access point table full

Explanation: The server's access point table does not have enough space to add a new access point. This message has a severity level of Error.

User Action: Remove one or more access points, or increase the table size by increasing the maximum permitted number of access points. To increase the maximum number of access points, edit the DFSSCONFIG.COM file. Change the value specified by the SET SERVER/ACCESS_POINTS_MAXIMUM command, and then restart the server.

ASCTOID, Error in Rightslist File for identifier

Explanation: An error occurred when the server accessed the rightslist file. Additional information follows. This message has a severity level of Warning.

User Action: See the information following the error message.

ASIZE_INIT, Failure scheduling or rescheduling persona cache autosize routine

Explanation: A system service failure has occurred while attempting to schedule or reschedule the periodic persona cache autosize routine that automatically adjusts the size of the persona cache. The persona cache threshold will remain static until the server is stopped and restarted. An additional message follows giving information about the cause of the failure. This message has a severity level of Error.

User Action: If the threshold value at the time of the failure is acceptable for current and future usage, you may not have to do anything. Most likely, you will find it necessary to correct the cause of the problem and stop and restart the server process.

Status Messages

ASNCHAN, Failure assigning I/O channel to device

Explanation: An error occurred during initialization of the server process. This message has a severity level of Error.

User Action: Verify that the server is properly installed (as described in the installation guide). If the problem persists, report it.

BADCHKSNT, DFS/COM Invalid checksum detected

Explanation: The specified node detected an invalid checksum on a message sent by this node. This message has a severity level of Error.

User Action: Verify that the network hardware is working properly. Enter the DFSSCONTROL command SHOW VERSIONS on both this node and the specified node to see whether they are running compatible versions of the DECdfs components. If they are not, install the proper software and then retry the operation. For information on version compatibility, see the release notes.

BADCHKSUM, DFS/COM invalid checksum on message received

Explanation: The DECdfs Communication Entity detected an invalid checksum. This message has a severity level of Error.

User Action: Verify that the network hardware is working properly. Enter the DFSSCONTROL command SHOW VERSIONS on both the client and server systems to see whether they are running compatible versions of the DECdfs components. If they are not, install the proper software and then retry the operation. For information on version compatibility, see the release notes.

BUF_SIZ_RANGE, The value given for the buffer size is out of range

Explanation: The specified value for the Communication Entity buffer size is outside the valid range. This message has a severity level of Error.

User Action: Repeat the operation, using an appropriate value. To display the range of correct values, use the DFSSCONTROL command SHOW COMMUNICATION/BUFFER_SIZE.

CACHE_QUOTA_RANGE, The value given for the cache buffers file quota is out of range

Explanation: The specified value for the buffer quota per file in the data cache is outside the valid range. This message has a severity level of Error.

User Action: Repeat the operation, using an appropriate value. To display the range of correct values, use the DFSSCONTROL command SHOW SERVER/DATA_CACHE=FILE_BUFFER_QUOTA.

CKMEM, Ck_memory error in function

Explanation: The server was unable to obtain the necessary memory resources to process the request. This message has a severity level of Warning.

User Action: See the additional message that follows for more information. Verify that the server is properly installed (as described in the installation guide). Verify that the size allocated for nonpaged pool is adequate. If the problem persists, report it.

CLIENTDEV, A DFS client device may not be added as an access point

Explanation: An ADD ACCESS_POINT command attempted to add a DECdfs client device as an access point. DECdfs does not allow your system to serve an access point for which it is a client; each system can serve only its own access points. This message has a severity level of Error.

User Action: None.

COMMABORT, Communication Entity aborted operation

Explanation: A DECnet error caused the Communication Entity to abort an operation. This message has a severity level of Fatal.

User Action: Verify that DECnet is operational. If it is, retry the operation. If the problem persists, report it.

COMMCLOSE, Communication Entity closed the connection

Explanation: The DECdfs Communication Entity disconnected a DECnet logical link. This message has a severity level of Fatal.

User Action: Verify that DECnet is operational. If it is, retry the operation. If the problem persists, report it.

COMMSTOP, Communication Entity is currently stopped

Explanation: This message has a severity level of Fatal.

User Action: To start the Communication Entity, execute the SYS\$STARTUP:DFS\$STARTUP.COM file.

CONFLICT_DELETED, **name deleted from name service despite node conflict**

Explanation: The REMOVE ACCESS_POINT command removed an access point name from DECdns, although another node had originally added the access point. An associated message identifies the other node. This message has a severity level of Information.

User Action: If you removed the access point accidentally, notify the system manager of the other node so that he or she can add the access point again.

COPYVECT, Error copying vector in function

Explanation: An error occurred while the server was processing a request. This message has a severity level of Warning.

User Action: Verify that the server is properly installed (as described in the installation guide). If the problem persists, report it.

CRELNM, Failure creating logical name in table

Explanation: An error occurred during initialization of the server process. This message has a severity level of Error.

User Action: Verify that the server is properly installed (as described in the installation guide). If the problem persists, report it.

CRMPSC, Failure creating global section

Explanation: During initialization of the server process, the server was unable to obtain the necessary memory resources. This message has a severity level of Error.

User Action: Verify that the server is properly installed (as described in the installation guide). Verify the settings for the SYSGEN parameters GBLSECTIONS and GBLPAGES. If the problem persists, report it.

Status Messages

CVT_TO_DNS_NAME, Error converting access point name to name space name

Explanation: An attempt was made to mount an access point utilizing the DECdns namespace on a DECdfs client system running DECnet Phase V. However, DECdns has not been defined as a directory service in the DECnet Phase V configuration. This message has a severity of Error.

User Action: Either use the /NODE qualifier to specify the DECdfs server node in the MOUNT command or reconfigure DECnet Phase V to include DECdns as one of its directory services.

DASSGN, DASSGN system service error in function on channel

Explanation: An internal error occurred during a DECdfs attempt to deassign a channel. This message has a severity level of Warning.

User Action: Verify your DECdfs installation (as described in the installation guide). If the problem persists, report it.

DATAOVERUN, DFS/COM Data overrun returned from DECnet

Explanation: The DECdfs Communication Entity received a data overrun error from DECnet. This message has a severity level of Error.

User Action: Verify that DECnet is operational. If it is, retry the operation. If the problem persists, report it.

DFSC0, The DFSC0: device is a template and contains no client information

Explanation: The SHOW CLIENT DFSC0: command was attempted. The DFSC0: client device is a template and does not represent an access point. This message has a severity level of Error.

User Action: Try the command again, using a DFSC device unit number of 1 or higher.

DISMNT_SUCCESS, Dismount was successfully performed

Explanation: The DISMOUNT command was successfully performed. This message has a severity level of Success.

User Action: None.

DNS_INVADDRESS, Encountered address attribute which is not a set

Explanation: DECdfs encountered an error interpreting information obtained from DECdns. Additional information follows. This message has a severity level of Error.

User Action: Ask your DECdns manager to verify the integrity of the DECdns directory and to check that the DECdfs and DECdns versions are compatible.

DNS_NAME_CONFLICT, DNS object name in use by another node or application

Explanation: The access point name is already in use by another node or application. Additional information follows. This message has a severity level of Error.

User Action: Choose a different access point name or remove the conflicting name.

DNS_SETNOTPRESENT, Address attribute set not present

Explanation: DECdfs encountered an error interpreting information obtained from DECdns. Additional information follows. This message has a severity level of Error.

User Action: Ask your DECdns manager to verify the integrity of the DECdns directory and to check that the DECdfs and DECdns versions are compatible.

ERROREXIT, Server exiting due to severe error

Explanation: The server process encountered a system error. This message has a severity level of Fatal.

User Action: Verify that the server is properly installed (as described in the installation guide). If the problem persists, report it.

EVENTUNKNOWN, DFS/COM Unknown event type

Explanation: The DECdfs Communication Entity has encountered an unexpected event. Additional information follows. This message has a severity level of Warning.

User Action: Verify that DECdfs for OpenVMS is properly installed (as described in the installation guide). If the problem persists, report it. Include the text of the system error messages that follow this message.

FAOGBLNAM, Failure formatting global section name

Explanation: An error occurred during initialization of the server process. This message has a severity level of Error.

User Action: Verify that the server is properly installed (as described in the installation guide). If the problem persists, report it.

FAOPRCNAM, Failure formatting new process name

Explanation: An error occurred during an attempt to initialize the server process. This message has a severity level of Error.

User Action: Verify that the server is properly installed (as described in the installation guide). If the problem persists, report it.

FB_GETDVIERR, GETDVI system service error in function

Explanation: A system service failure has occurred while attempting to find the number of free blocks on a DFS-served device. An additional message follows giving information about the cause of the failure. This message has a severity level of Warning.

User Action: Correct the cause of the failure.

FIL_TRUNC, Active file information display truncated, maximum buffer size limit exceeded

Explanation: The information buffer used to format the display of currently open files (SHOW SERVER /ACTIVE command) is large enough to contain information on approximately 500 files. The number of files currently open is more than that limit. The header line of the display shows the correct count of open files. This message has a severity level of Information.

User Action: None.

Status Messages

FIND_HELD, Error in rightslist file for UIC

Explanation: An error occurred during access of the rightslist file. This message has a severity level of Warning. Additional information follows.

User Action: See the information following the error message.

GENPROTOCOL, Protocol version mismatch detected

Explanation: A protocol version incompatibility has been detected. The incompatibility can be between the client and server, between DFSS\$CONTROL on this node and a remote server, or between the communication entities on this node and the remote node. This message has a severity level of Fatal.

User Action: Use the DFSS\$CONTROL command SHOW VERSIONS on both the server system and the client system, and compare the version numbers. If the versions are incompatible, install the proper software. For information on version compatibility, see the DECdfs for OpenVMS release notes.

GETCTLINFO, Unable to obtain control information

Explanation: An error occurred during initialization of the server process. This message has a severity level of Error.

User Action: Verify that the server is properly installed (as described in the installation guide). If the problem persists, report it.

GETDVIW, Failure getting device information

Explanation: An error occurred during initialization of the server process. This message has a severity level of Error.

User Action: Verify that the server is properly installed (as described in the installation guide). If the problem persists, report it.

GETELE, Error decoding element

Explanation: The server received an incorrect internal request. This message has a severity level of Warning.

User Action: Verify that the server is properly installed (as described in the installation guide). If the problem persists, report it.

GETFUNC, Error decoding function identifier in server

Explanation: The server received an incorrect internal request. This message has a severity level of Warning.

User Action: Verify that the server is properly installed (as described in the installation guide). If the problem persists, report it.

GETSAID, Failure getting service agent identifier

Explanation: An error occurred during initialization of the server process. This message has a severity level of Error.

User Action: Verify that the server is properly installed (as described in the installation guide). If the problem persists, report it.

GETUAI, Error in User Authorization File for user

Explanation: An error occurred during access of the user authorization file. Additional information follows. This message has a severity level of Warning.

User Action: See the information following the error message.

ILLWQEFNC, DFS/COM Illegal work queue entry function

Explanation: The DECdfs Communication Entity detected an illegal internal function. This message has a severity level of Warning.

User Action: Verify that the server is properly installed (as described in the installation guide). If the problem persists, report it.

INACTIVE, DFS/COM connection deaccessed because inactive

Explanation: The Communication Entity disconnected an inactive link. This is a normal timeout function of the Communication Entity. This message has a severity level of Error.

User Action: None; the next operation for that connection will establish a new link. If you want to change the frequency of the timeouts, use the DFS\$CONTROL command SET COMMUNICATION/SCAN_TIME.

INSFRES, DFS/COM insufficient server resources

Explanation: The DECdfs Communication Entity had insufficient system resources to satisfy a request. This message has a severity level of Error.

User Action: This is probably an OpenVMS resource problem. Check the nonpaged pool on your system, using the DCL command SHOW MEMORY/POOL; increase the value for the SYSGEN parameter NPAGEDYN if necessary. Verify that the server is properly installed (as described in the installation guide). If the problem persists, report it.

INSFRES_CONN, DFS/COM Insufficient connection resources

Explanation: The Communication Entity has insufficient resources to satisfy a request. This message has a severity level of Error.

User Action: This problem can occur when OpenVMS has insufficient nonpaged pool. Check the nonpaged pool on your system, using the DCL command SHOW MEMORY/POOL; increase the value for the SYSGEN parameter NPAGEDYN if necessary.

Check the maximum permitted DECnet logical links. To display the DECnet logical links maximum, use the appropriate command, as follows:

For DECnet Phase IV:

Use the NCP command SHOW EXECUTOR CHARACTERISTICS. To set maximum logical links, use the NCP commands SET EXECUTOR MAXIMUM LINKS and DEFINE EXECUTOR MAXIMUM LINKS.

For DECnet Phase V:

Use the NCL command SHOW NSP ALL. To set maximum transport connections, use the following NCL commands:

1. DISABLE NODE [node-id] NSP
2. SET NODE [node-id] NSP MAXIMUM TRANSPORT CONNECTIONS
3. ENABLE NODE [node-id] NSP

Check your DECdfs installation, according to the instructions in the installation guide. If the problem persists, report it.

Status Messages

INSFRES_SESS, DFS/COM Insufficient session resources

Explanation: The DECdfs Communication Entity has insufficient resources to satisfy a request. This message has a severity level of Error.

User Action: First, check that OpenVMS has sufficient resources to meet the needs of DECdfs for OpenVMS. Check the nonpaged pool on your system, using the DCL command SHOW MEMORY/POOL; increase the value for the SYSGEN parameter NPAGEDYN if necessary. Check the SYSGEN channel count parameter, CHANNELCNT.

Next, verify DECdfs values. Check the DECdfs process file limit, DFS\$PQL_FILLM, which is defined in the DFS\$CONFIG.COM file. Also check the system's maximums for DECnet logical links. To display the DECnet logical links maximum, use the appropriate command, as follows:

For DECnet Phase IV:

Use the NCP command SHOW EXECUTOR CHARACTERISTICS. To set maximum logical links, use the NCP commands SET EXECUTOR MAXIMUM LINKS and DEFINE EXECUTOR MAXIMUM LINKS.

For DECnet Phase V:

Use the NCL command SHOW NSP ALL. To set maximum transport connections, use the following NCL commands:

1. DISABLE NODE [node-id] NSP
2. SET NODE [node-id] NSP MAXIMUM TRANSPORT CONNECTIONS integer
3. ENABLE NODE [node-id] NSP

Check your DECdfs installation, according to the instructions in the installation guide. If the problem persists, report it.

INSFRES_XACT, DFS/COM Insufficient transaction resources

Explanation: The DECdfs Communication Entity has insufficient resources to satisfy a request. This message has a severity level of Error.

User Action: This is probably an OpenVMS resource problem. Check the nonpaged pool on your system, using the DCL command SHOW MEMORY/POOL; increase the value for the SYSGEN parameter NPAGEDYN if necessary. Verify that the server is properly installed (as described in the installation guide). If the problem persists, report it.

INV_DNSADDRESS, Encountered access point incorrectly stored with DNS

Explanation: DECdfs encountered an error interpreting information obtained from DECDns. Additional information follows. This message has a severity level of Error.

User Action: Ask your DECDns manager to verify the integrity of the DECDns directory and to check that the DECdfs and DECDns versions are compatible.

INVAL_SUCCESS, The persona cache has been invalidated

Explanation: DECdfs successfully invalidated the persona cache. This message has a severity level of Success.

User Action: None.

INVCONN, DFS/COM Invalid or inactive connection ID

Explanation: An internal error occurred during an attempt to communicate with the remote system. This message has a severity level of Error.

User Action: Verify the DECdfs installation (as described in the installation guide). Next, check that the DECdfs Communication Entity is running by entering the DFSSCONTROL command SHOW COMMUNICATION/STATUS. If the problem persists, report it.

INVCONNID, Invalid connection identifier specified for operation

Explanation: An internal error occurred during an attempt to communicate with the remote system. This message has a severity level of Fatal.

User Action: Verify the DECdfs installation (as described in the installation guide). Next, check that the DECdfs Communication Entity is running by entering the DFSSCONTROL command SHOW COMMUNICATION/STATUS. If the problem persists, report it.

INVSESS, DFS/COM Invalid or inactive session ID

Explanation: An internal error occurred during an attempt to communicate with the DECdfs server. This message has a severity level of Error.

User Action: Verify the DECdfs installation (as described in the installation guide). Next, check that the DECdfs Communication Entity is running by entering the DFSSCONTROL command SHOW COMMUNICATION/STATUS. If the problem persists, report it.

INVSESSID, Invalid session identifier specified for operation

Explanation: An internal error occurred during an attempt to communicate with the DECdfs server. This message has a severity level of Fatal.

User Action: Verify the DECdfs installation (as described in the installation guide). Next, check that the DECdfs Communication Entity is running by entering the DFSSCONTROL command SHOW COMMUNICATION/STATUS. If the problem persists, report it.

INVSWBREQ, Server received invalid special request

Explanation: The server received an incorrect internal request. This message has a severity level of Fatal.

User Action: Verify the server installation (as described in the installation guide). Next, check that the DECdfs Communication Entity is running by entering the DFSSCONTROL command SHOW COMMUNICATION/STATUS. If the problem persists, report it.

INVTIMEVAL, Invalid time value

Explanation: DECdfs detected an invalid time value. This message has a severity level of Error.

User Action: Repeat the operation, using an appropriate value. To view the range of correct values, enter the DFSSCONTROL command SHOW COMMUNICATION/SCAN_TIME.

Status Messages

INVUSER, DFS/COM invalid remote user name

Explanation: The Communication Entity received a connect request from a remote process that was not another DECdfs Communication Entity. This message and the NOTREMOTECOM message are paired. This message has a severity level of Error.

User Action: DECdfs rejected this connect request. However, this message can indicate a break-in attempt and should be investigated.

INWVQE, DFS/COM Invalid work queue entry type

Explanation: The DECdfs Communication Entity detected an illegal internal function. This message has a severity level of Warning.

User Action: Verify that the server is properly installed (as described in the installation guide). If the problem persists, report it.

INVWRKREQ, Server received invalid work request

Explanation: The DECdfs server received an invalid internal request. This message has a severity level of Error.

User Action: Verify that the server is properly installed (as described in the installation guide). If the problem persists, report it.

IOACCESS, I/O failure accessing kernel device

Explanation: An error occurred during initialization of the server process. This message has a severity level of Error.

User Action: Verify that the server is properly installed (as described in the installation guide). If the problem persists, report it.

IOGETDVIW, I/O Failure getting device information

Explanation: An error occurred during initialization of the server process. This message has a severity level of Error.

User Action: Verify that the server is properly installed (as described in the installation guide). If the problem persists, report it.

IOGETSAID, I/O failure getting service agent identifier

Explanation: An error occurred during initialization of the server process. This message has a severity level of Error.

User Action: Verify that the server is properly installed (as described in the installation guide). If the problem persists, report it.

KERNEL_INVSTATE, DFS kernel detected inconsistent state

Explanation: The server has detected an error condition. This message has a severity level of Fatal.

User Action: Verify that the server is properly installed (as described in the installation guide). If the problem persists, report it.

KERNEL_STARTUP, server kernel version running

Explanation: The server process initialized successfully. This message has a severity level of Information.

User Action: None.

KNL_CALLBACK, Server kernel callback error

Explanation: The server was unable to respond to a client request. This message has a severity level of Warning.

User Action: Verify that the server is properly installed (as described in the installation guide). If the problem persists, report it.

LKWSET, Failure locking code into working set

Explanation: An error occurred during creation of the server process. This message has a severity level of Error.

User Action: Verify that the server is properly installed (as described in the installation guide). Consider increasing the values for the DFSSPQL_WSQUOTA and/or DFSSPQL_WSEXTENT parameter in the DFSSCONFIG.COM file. If the problem persists, report it.

MBX_READ_ERR, DFS/COM Error reading network mailbox

Explanation: The DECdfs Communication Entity received an error. This message has a severity level of Error.

User Action: Verify that the server is properly installed (as described in the installation guide). Also verify that DECnet is operational. If the problem persists, report it.

MGBLSC, Failure mapping global section

Explanation: An error occurred during creation of the server process. This message has a severity level of Error.

User Action: Verify that the server is properly installed (as described in the installation guide). Verify that the SYSGEN parameters GBLSECTIONS and GBLPAGES are set properly. If the problem persists, report it.

NET_ABORT, DFS/COM network partner aborted link

Explanation: The Communication Entity received a DECnet message that the network partner disconnected the link. This message has a severity level of Information.

User Action: Verify that DECnet and the server are operational. If so, retry the operation. The Communication Entity will reestablish the network connection at the next file-access attempt. If the problem persists, report the problem.

NET_CONFIRM, DFS/COM network connect confirm

Explanation: DECnet has successfully established a logical link. This message has a severity level of Information.

User Action: None.

NET_CONNECT, DFS/COM network inbound connect initiate

Explanation: DECnet received a logical link request for DECdfs. This message has a severity level of Information.

User Action: None.

Status Messages

NET_DISCON, DFS/COM network partner disconnected

Explanation: The DECnet logical link has been disconnected because of problems with the network partner. This message has a severity level of Information.

User Action: Verify that DECnet and the server are operational. If so, retry the operation. If the problem persists, report it.

NET_EXIT, DFS/COM network partner exited prematurely

Explanation: The DECnet logical link has been disconnected because the network partner exited. This message has a severity level of Information.

User Action: Verify that DECnet and the server are operational. If so, retry the operation. If the problem persists, report it.

NET_INTMSG, DFS/COM network interrupt message (unsolicited data)

Explanation: DECnet received an unexpected network message. This message has a severity level of Information.

User Action: Verify that DECnet and the server are operational. If so, retry the operation. If the problem persists, report it.

NET_NETSHUT, DFS/COM network shutting down

Explanation: DECnet is shutting down. This message has a severity level of Information.

User Action: Terminate the current operations in an orderly manner.

NET_PATHLOST, DFS/COM path lost to network partner

Explanation: DECnet lost the path to the network partner. This message has a severity level of Information.

User Action: Verify that DECnet and DECdfs are operational. Also check that the remote server is still operational by entering the appropriate command, as follows:

For DECnet Phase IV:

Use the NCP command `SHOW NODE node-id STATUS`.

For DECnet Phase V:

Use the NCL command `SHOW NODE node-id ALL STATUS`.

Substitute the node name or address for *node-id*.

Retry the operation. If the problem persists, report it.

NET_PROTOCOL, DFS/COM network protocol error

Explanation: DECnet is reporting a network protocol error. This message has a severity level of Information.

User Action: Verify that DECnet and DECdfs are operational. If so, retry the operation. If the problem persists, report it.

NET_REJECT, DFS/COM rejected connection

Explanation: DECnet rejected a logical link request. This message has a severity level of Information.

User Action: Verify that DECnet and DECdfs are operational. If so, retry the operation. If the problem persists, report it.

NET_THIRDPARTY, DFS/COM network third party disconnect

Explanation: DECnet is reporting a third-party disconnect. This message has a severity level of Information.

User Action: Verify that DECnet and DECdfs are operational. Also check that the remote server is still operational by entering the appropriate command, as follows:

For DECnet Phase IV:

Use the NCP command SHOW NODE *node-id* STATUS.

For DECnet Phase V:

Use the NCL command SHOW NODE *node-id* ALL STATUS.

Substitute the node name or address for *node-id*.

Retry the operation. If the problem persists, report it.

NET_TIMEOUT, DFS/COM connection timed out

Explanation: An attempt to establish a DECnet logical link has timed out. This message has a severity level of Information.

User Action: Verify that DECnet and DECdfs are operational. If so, retry the operation. If the problem persists, report it.

NET_UNKNOWN, DFS/COM unknown network message received

Explanation: DECnet is reporting an invalid network message. This message has a severity level of Information.

User Action: Verify that DECnet and DECdfs are operational. If so, retry the operation. If the problem persists, report it.

NETADDRTONAME, DFS/COM error translating node address to node name

Explanation: The attempted operation required DECnet to translate a DECnet node address to a node name. This caused an error of severity level Error. A system service error message follows.

User Action: See Help Message or the *HP OpenVMS System Services Reference Manual* for specific information about the system service message. Verify that DECnet and DECdfs are operational. If they are, and you know which node caused the error, verify that the DECnet database is up to date by entering the NCP or NCL command SHOW NODE *node-id*. Substitute the node name or address for *node-id*. Try the operation again. If the problem persists, report it.

NETADDRTONAMEIO, DFS/COM I/O error translating node address to node name

Explanation: The attempted operation required DECnet to translate a DECnet node address to a node name. This caused an error of severity level Error. A system service error message follows.

User Action: See Help Message or the *HP OpenVMS System Services Reference Manual* for specific information about the system service message. Verify that DECnet and DECdfs are operational. If they are, and you know which node caused the error, verify that the DECnet database is up to date by entering the NCP or NCL command SHOW NODE *node-id*. Try the operation again. If the problem persists, report it.

Status Messages

NETASSIGN, DFS/COM error assigning network device

Explanation: An internal error (of severity level Error) occurred when the DECdfs Communication Entity attempted to assign a channel for DECnet use. A system service error message follows.

User Action: See Help Message or the *HP OpenVMS System Services Reference Manual* for specific information about the system service message. Verify that DECnet and DECdfs are operational. If they are, try the operation again. If the problem persists, report it.

NETCONFIO, DFS/COM I/O error confirming connection

Explanation: An error occurred when DECnet tried to confirm a logical link that serves a DECdfs connection. This message has a severity level of Error. A system service error message follows.

User Action: See Help Message or the *HP OpenVMS System Services Reference Manual* for specific information about the system service message. Verify that DECnet and DECdfs are operational. If they are, try the operation again. If the problem persists, report it.

NETCONFQIO, DFS/COM directive error confirming connection

Explanation: An error occurred when DECnet tried to confirm a logical link for DECdfs. This message has a severity level of Error. A system service error message follows.

User Action: See Help Message or the *HP OpenVMS System Services Reference Manual* for specific information about the system service message. Verify that DECnet and the DECdfs entities are operational. If they are, retry the operation. If the problem persists, report it.

NETCONNIO, DFS/COM I/O error initiating connection to node

Explanation: An error occurred when DECnet tried to initiate a logical link for DECdfs. This message has a severity level of Error. A system service error message follows.

User Action: See Help Message or the *HP OpenVMS System Services Reference Manual* for specific information about the system service message. Verify that DECnet and the DECdfs entities are operational. If they are, retry the operation. If the problem persists, report it.

NETCONNQIO, DFS/COM directive error initiating connection

Explanation: An error occurred when DECnet tried to initiate a logical link for DECdfs. A system service error message follows. This message has a severity level of Error.

User Action: See Help Message or the *HP OpenVMS System Services Reference Manual* for specific information about the system service message. Verify that DECnet and DECdfs are operational. If they are, try the operation again. If the problem persists, report it.

NETDEACIO, DFS/COM I/O error deaccessing network link

Explanation: An error occurred when the Communication Entity tried to deaccess a DECnet link. This message has a severity level of Error. A system service error message follows.

User Action: See Help Message or the *HP OpenVMS System Services Reference Manual* for specific information about the system service message. Verify that DECnet and DECdfs are operational. If they are, retry the operation. If the problem persists, report it.

NETDEACQIO, DFS/COM directive error deaccessing network link

Explanation: An error occurred when the Communication Entity attempted to deaccess a DECnet link. This message has a severity level of Error. A system service error message follows.

User Action: See Help Message or the *HP OpenVMS System Services Reference Manual* for specific information about the system service message. Verify that DECnet and DECdfs are operational, and if so, retry the operation. If the problem persists, report it.

NETDEASSGN, DFS/COM error deassigning network device

Explanation: An error occurred when the Communication Entity attempted to deassign a channel assigned to DECnet. This message has a severity level of Error. A system service error message follows.

User Action: See Help Message or the *HP OpenVMS System Services Reference Manual* for specific information about the system service message. Verify that DECnet and the DECdfs entities are operational. If they are, retry the operation. If the problem persists, report it.

NETDISCON, DFS/COM directive error disconnecting network link

Explanation: An error occurred when the DECdfs Communication Entity attempted to disconnect a DECnet link. A system service error message follows. This message has a severity level of Information.

User Action: See Help Message or the *HP OpenVMS System Services Reference Manual* for specific information about the system service message. Verify that DECnet and DECdfs are operational. If they are, retry the operation. If the problem persists, report it.

NETDISCONIO, DFS/COM I/O error disconnecting network link

Explanation: An error occurred when the DECdfs Communication Entity attempted to disconnect a DECnet link. A system service error message follows. This message has a severity level of Error.

User Action: See Help Message or the *HP OpenVMS System Services Reference Manual* for specific information about the system service message. Verify that DECnet and DECdfs are operational. If they are, retry the operation. If the problem persists, report it.

NETGETDVI, DFS/COM directive error getting network device information

Explanation: An error occurred when the DECdfs Communication Entity attempted to access DECnet. This message has a severity level of Error.

User Action: Verify that DECnet is operational. If it is, retry the operation. If the problem persists, report it.

Status Messages

NETGETDVIO, DFS/COM I/O error getting network device information

Explanation: An error occurred when the DECdfs Communication Entity attempted to access DECnet. This message has a severity level of Error.

User Action: Verify that DECnet is operational. If it is, retry the operation. If the problem persists, report it.

NETNAMETOADDR, DFS/COM error translating node name to node address

Explanation: An error occurred when DECnet attempted to translate a node name to a node address. This message has a severity level of Error.

User Action: Verify that DECnet is operational. If it is, retry the operation. If the problem persists, report it.

NETNAMETOADDRIO, DFS/COM I/O error translating node name to node address

Explanation: An error occurred when DECnet attempted to translate a node name to a node address. This message has a severity level of Error.

User Action: Verify that DECnet is operational. If it is, retry the operation. If the problem persists, report it.

NETPROXY_CLOSE, Failure to close netproxy file

Explanation: An RMS failure occurred while attempting to close the netproxy file during processing for the SET SERVER /INVALIDATE_PERSONA_CACHE command. The DECdfs server process continues to use the currently open netproxy file. This message has a severity level of Warning. One or more additional messages give information about the cause of the RMS failure.

User Action: If you were not attempting to replace the netproxy file, no action is needed. Otherwise, correct the cause of the RMS failure and try the SET SERVER /INVALIDATE_PERSONA_CACHE command again.

NETPROXY_CONN, Failure to connect netproxy file rab

Explanation: The DECdfs server encountered an error in accessing the proxy (NETPROXY) file. This message has a severity level of Error. Additional information follows.

User Action: See the information following the error message.

NETPROXY_OPEN, Failure to open netproxy file

Explanation: The DECdfs server encountered an error when it tried to access the proxy (NETPROXY) file. This message has a severity level of Warning. Additional information follows.

User Action: See the information following the error message.

NETPROXY_READ, Failure to read netproxy file record for user

Explanation: The DECdfs server encountered an error when it tried to access the proxy (NETPROXY) file. This message has a severity level of Warning. Additional information follows.

User Action: See the information following the error message.

NETREJECTERR, DFS/COM error rejecting connection

Explanation: An error occurred when DECnet attempted to reject a logical link request. This message has a severity level of Error.

User Action: Verify that DECnet is operational. If it is, retry the operation. If the problem persists, report it.

NOAPTREG, No access points registered

Explanation: There are no access points in the server database. This message has a severity level of Warning.

User Action: If you are at a client and you get this message about a remote server, contact the DECdfs manager of the server. If you are at a server and you get this message about the local server database, you can enter the DFSSCONTROL command ADD ACCESS_POINT to add access points.

NOCOMMLOAD, Communication Entity has not been loaded

Explanation: You may not have executed the procedure to load the DECdfs Communication Entity device driver and Ancillary Control Process (ACP). This message has a severity level of Fatal.

User Action: To determine if the Communication Entity is running, enter the DFSSCONTROL command SHOW COMMUNICATION/STATUS. If it is not, execute the SYSSSTARTUP:DFSSSTARTUP.COM file.

NOCONNMEM, Insufficient memory to create new connection

Explanation: An error occurred when the DECdfs Communication Entity attempted to create a connection. This message has a severity level of Fatal.

User Action: Verify that the server is properly installed (as described in the installation guide). If the problem persists, report it.

NODEVNAM, Device name missing

Explanation: A device name was missing or had improper syntax in the ADD ACCESS_POINT command. This message has a severity level of Error.

User Action: Retry the operation. Ensure that your device specification is valid and includes a colon (:).

NORQSTMEM, Insufficient memory to perform operation

Explanation: The DECdfs Communication Entity could not allocate sufficient memory to complete the request. This message has a severity level of Fatal.

User Action: Verify that DECdfs is installed properly (as described in the installation guide). Check the setting for the SYSGEN parameter NPAGEDYN. If the problem persists, report it.

NOESSMEM, Insufficient memory to start new operation

Explanation: The DECdfs Communication Entity could not allocate sufficient memory to complete the request. This message has a severity level of Fatal.

User Action: Verify that the DECdfs is properly installed (as described in the installation guide). Check that you have set the SYSGEN parameter NPAGEDYN properly. If the problem persists, report it.

Status Messages

NOT_PRIVED, Insufficient privilege for this operation

Explanation: This command requires privileges that this process does not have. This message has a severity level of Error.

User Action: See the DFSSCONTROL command chapter in <REFERENCE>(dfs_man_guide), which lists the required privileges in the command descriptions.

NOTREMOTECOM, DFS/COM connection attempted by non-DFS/COM module on node

Explanation: The Communication Entity received a connect request from a remote process that was not another DECdfs Communication Entity. This message and the INVUSER message are paired. This message has a severity level of Error.

User Action: DECdfs rejected this connect request. However, this message can indicate a break-in attempt and should be investigated.

NOTRUNNING, DFS/COM Remote DFS/COM module not running

Explanation: The DECdfs Communication Entity detected that the remote DFSSCOM_ACP process is not functioning. This message has a severity level of Error.

User Action: Inform the DECdfs manager at the remote system.

NOTSERVED, Access point is not presently being served

Explanation: The DFSSCONTROL command MOUNT or SHOW ACCESS_POINT/FULL queried DECdns about the name of an access point and then created a connection to the relevant DECdfs server. Although the DECdns namespace contained the name of the access point, the server did not recognize the name. This can occur when the server stops and restarts without the name of the access point being re-added. This message has a severity level of Warning.

User Action: Wait a short time and then try the operation again. The server may be starting up and may recognize the name of the access point when startup completes. If it does not, notify the DECdfs manager at the server.

NSPERROR, DECnet error has been detected

Explanation: The DECdfs Communication Entity received an error from DECnet. This message has a severity level of Fatal.

User Action: Verify that DECnet is running properly and check DECnet event logs for unusual occurrences. If the problem persists, report it.

OLDCOMM, Communication Entity has been stopped and restarted

Explanation: The DECdfs Communication Entity has been stopped and restarted. This message has a severity level of Fatal.

User Action: None. The DECdfs client will retry the operation.

PERSCA_INIT, Insufficient non-paged pool to initialize persona cache

Explanation: An error occurred while starting the DECdfs server. The server was unable to obtain the necessary memory resources. This message has a severity level of Error.

User Action: Verify that the server is properly installed (as described in the installation guide). Check the setting for the SYSGEN parameter NPAGEDYN. If the problem persists, report it.

PERSONA_UPDATE_RANGE, The value given for the persona cache update interval is out of range

Explanation: The value specified for the lifetime of individual persona blocks is outside the valid range. This message has a severity level of Error.

User Action: Repeat the operation using a permitted value. To display the range of permitted values, use the DFS\$CONTROL command SHOW SERVER/PERSONA_CACHE_UPDATE_INTERVAL.

PROTOCOL, DFS/COM protocol version mismatch

Explanation: The DECdfs Communication Entity detected a protocol version error between itself and the DECdfs Communication Entity at the other node. This message has a severity level of Error.

User Action: Use the DFS\$CONTROL command SHOW VERSIONS to check the DECdfs component versions on both client and server, and then install the correct software if necessary. For information on version compatibility, see the release notes.

PROXYFMT, Incompatible netproxy record format

Explanation: This version of DECdfs cannot be run as a server under this version of OpenVMS. This message has a severity level of Warning.

User Action: Install compatible versions of DECdfs and OpenVMS. For information about the DECdfs operating system requirements, see the installation guide.

RCVDDATA, DFS/COM Received data from transport

Explanation: The DECdfs Communication Entity received network data. This message has a severity level of Information.

User Action: None.

REMMCOMMSTOP, Remote communication entity is currently stopped

Explanation: The DECdfs Communication Entity detected that the remote DFS\$COM_ACP process is not functioning. This message has a severity level of Fatal.

User Action: Ask the DECdfs manager on the remote server to correct the problem. If the problem persists, report it.

REMTESHUT, DFS/COM remote node shutting down

Explanation: DECnet is shutting down on the remote node. This message has a severity level of Information.

User Action: None; this message is informational only. Note that since the DECdfs Communication Entity can have a DECnet connection between a local client and a local server, this message might also appear when DECnet shuts down on the local node.

REMREREJECT, Communication entity rejected operation for an unknown reason

Explanation: The DECdfs Communication Entity returned an error. This message has a severity level of Error.

User Action: Verify that DECdfs is properly installed (as described in the installation guide). If the problem persists, report it.

Status Messages

REMRSRC, Server has insufficient resources to perform operation

Explanation: The DECdfs Communication Entity could not perform the requested operation because the server had insufficient resources. This message has a severity level of Error.

User Action: If you are at a DECdfs server, verify that DECdfs is properly installed (as described in the installation guide), paying particular attention to the values for the NPAGEDYN SYSGEN parameter and the following parameter:

For DECnet Phase IV:

NCP parameter MAXIMUM LINKS

For DECnet Phase V:

NCL parameter MAXIMUM TRANSPORTS CONNECTIONS

If you are at a DECdfs client, inform the DECdfs manager at the remote server.

REMWILDCARD, Wildcards may not be used to remove access points

Explanation: You can specify only one access point name at a time with the command REMOVE ACCESS_POINT. This message has a severity level of Error.

User Action: Use one command to remove each access point; specify an access point with each command.

RRABORT, DFS/COM aborted session

Explanation: The DECdfs Communication Entity encountered a fatal error and aborted the session. This occurs on a client when the remote server shuts down or otherwise aborts communication with the client. Additional information follows. This message has a severity level of Error.

User Action: See the additional information that follows the error message. Verify that DECnet is operational. Also check that the remote server is still operational by entering the NCP or NCL command SHOW NODE *node-id* STATUS. Retry the operation. If the problem persists, report it.

SANOTACTIVE, Specified service agent is not currently active

Explanation: The server is not running. This message has a severity level of Error.

User Action: Verify that DECnet is operational. If it is, restart the DECdfs entity by executing the command file SYSSSTARTUP:DFSSSTARTUP.COM. If the problem persists, report it.

SAUNKNWN, DFS/COM service agent unknown

Explanation: There is no server available to process the request. This message has a severity level of Error.

User Action: Verify that DECnet is operational. If it is, restart DECdfs by executing the command file SYSSSTARTUP:DFSSSTARTUP.COM. If the problem persists, report it.

SCAN_TIME_RANGE, The value given for the scan time is out of range

Explanation: The specified Communication Entity scan time was outside the permitted range. This message has a severity level of Error.

User Action: Repeat the operation, using an appropriate value. To display the permitted range of scan times, enter the DFS\$CONTROL command SHOW COMMUNICATION/SCAN_TIME.

SESSERR, DFS/COM NSP session layer error occurred

Explanation: The DECdfs Communication Entity is reporting an error that involves local DECnet software. This message has a severity level of Error.

User Action: Verify that DECnet is operational. If it is, retry the operation. If the problem persists, report it.

SESSREADERR, DFS/COM error from session layer read operation

Explanation: The DECdfs Communication Entity encountered an error in communicating with local DECnet software. Additional information follows. This message has a severity level of Warning.

User Action: Verify that DECnet is operational. If it is, retry the operation. If the problem persists, report it.

SESSWRITEERR, DFS/COM Error from session layer write operation

Explanation: The DECdfs Communication Entity encountered an error in communicating with local DECnet software. Additional information follows. This message has a severity level of Warning.

User Action: Verify that DECnet is operational. If it is, retry the operation. If the problem persists, report it.

SETDDIR, Failure setting default directory

Explanation: While initializing, the server was unable to set the default directory for its process. Additional information follows. This message has a severity level of Error.

User Action: Verify that the server is properly installed (as described in the installation guide). If the problem persists, report it.

SETIMR, DFS/COM I/O error setting up connection scan timer

Explanation: The DECdfs Communication Entity received an error. Additional information follows. This message has a severity level of Warning.

User Action: Verify that the local system is properly installed (as described in the installation guide). If the problem persists, report it.

SETPRN, Failure setting new process name

Explanation: The DECdfs Communication Entity received an error while attempting to set the process name. Additional information follows. This message has a severity level of Error.

User Action: Verify that the local system is properly installed (as described in the installation guide). If the problem persists, report it.

SETPRT, Failure setting protection of special kernel stack guard page

Explanation: The DECdfs Communication Entity received an error. Additional information follows. This message has a severity level of Error.

User Action: Verify that the local system is properly installed (as described in the installation guide). If the problem persists, report it.

Status Messages

SNAP_BAD_VERSION, The snapshot file version is out of date

Explanation: The file specification entered with the /SNAPSHOT_FILE qualifier referred to a snapshot file that is older than the current version of the DFSSCONTROL program. The file format is incompatible with the current program. This message has a severity level of Error.

User Action: The old snapshot file is obsolete and cannot be used. Create a new snapshot file.

SNAP_NOT_COMM, Snapshot file does not contain communication entity counters

Explanation: The file specification entered with the /SNAPSHOT_FILE qualifier and specified for use with the SHOW COMMUNICATION/COUNTERS command referred to a file that does not contain communications counters. This message has a severity level of Error.

User Action: The file contains server or client counters. Use a snapshot file that contains communication counters.

SNAP_NOT_SERVER, Snapshot file does not contain server counters

Explanation: The file specification entered with the /SNAPSHOT_FILE qualifier and specified for use with the SHOW SERVER/COUNTERS command referred to a file that does not contain server counters. This message has a severity level of Error.

User Action: The file contains communication or client counters. Use a snapshot file that contains server counters.

SNAP_TOO_OLD, The snapshot file contains data from before the startup of the entity

Explanation: The snapshot file contains snapshot data that is older than the counters currently maintained by the specified entity. A comparison of the counters therefore would be meaningless or misleading. This message has a severity level of Error.

User Action: The old snapshot file is obsolete and cannot be used. Create a new snapshot file.

SOME_RANGE, A value given was out of range

Explanation: The specified value is outside the valid range. An additional message follows and specifies the incorrect value. This message has a severity level of Error.

User Action: Repeat the operation, using an appropriate value. To display the range of correct values, use one of the DFSSCONTROL SHOW commands.

SRVABORT, Server aborted operation

Explanation: The DECDfs Communication Entity could not complete a server operation. This message has a severity level of Fatal.

User Action: Verify that the server is properly installed (as described in the installation guide) and that the server is running. If the problem persists, report it.

SRVACTIVE, File server is already active

Explanation: The START SERVER command was entered but the server was already running. This message has a severity level of Warning.

User Action: None.

SRVEXIT, Server exiting

Explanation: The server process is terminating. This message has a severity level of Information.

User Action: None.

SRVNOTACT, The DFS Server is presently unavailable

Explanation: It is necessary to start the server before DECdfs can execute your request. This message has a severity level of Error.

User Action: Follow these instructions to start the server:

1. Check if the DECdfs server has been loaded by typing at the DCL prompt:

```
$ SHOW DEVICE DFSS0
```

If you receive the DCL error message "%SYSTEM-W-NOSUCHDEV, no such device available," perform Step 2. Otherwise, skip to Step 3.

2. Load the DECdfs server using the OpenVMS SYSGEN Utility, as follows:

```
$ RUN SYS$SYSTEM:SYSGEN
SYSGEN> CONNECT DFSS0/NOADAPTER/DRIVER=DFSSDRIVER
```

3. Use the DECdfs DFSSCONTROL management program to start the server:

```
$ RUN SYS$SYSTEM:DFSSCONTROL
DFSCP> START SERVER
```

SRVNOTLOAD, File service driver not loaded

Explanation: The server process has not been started. This message has a severity level of Error.

User Action: Invoke DFSSSTARTUP to start the server.

SRVRUNNING, Server running

Explanation: The server process has initialized successfully and is running. This message has a severity level of Information.

User Action: None.

STKLKWSET, Failure locking special kernel stack into working set

Explanation: An error occurred during creation of the server process. This message has a severity level of Error.

User Action: Verify that the server is properly installed (as described in the installation guide). Consider increasing the values for the DFSSPQL_WSQUOTA or DFSSPQL_WSEXTENT parameter or both, in the DFSSCONFIG.COM file. If the problem persists, report it.

TRANSAPID, Error translating access point identifier

Explanation: The DECdfs server attempted to access an access point that is currently invalid. This message has a severity level of Warning.

User Action: Check that your DFSSSYSTARTUP command procedure adds all of the usual access points on the system each time the server starts up. You might have stopped and restarted the server without adding all of the access points. At the client, the DECdfs mount verification procedure will attempt to recover from this error.

Status Messages

TRANSAPNM, Error translating access point name

Explanation: The DECdfs server attempted to translate an invalid access point name in response to a client's mount request or mount verification attempt. This message has a severity level of Warning.

User Action: Use the DFSS\$CONTROL command SHOW ACCESS_POINT/LOCAL to verify the access point name. If the access point name is not displayed, try adding it by using the ADD ACCESS_POINT command. Check that your DFSS\$STARTUP command procedure adds all of the usual access points on the system each time the server starts up.

UNKNOWN_ACCPT, Access point not known to name service

Explanation: The specified access point has not been added to the DECdns namespace by a DECdfs server. This message has a severity level of Error.

User Action: Check that you are entering the access point name correctly. Display the valid access point names, using the DFSS\$CONTROL command SHOW ACCESS_POINT. If the access point does not exist, contact the DECdfs manager at the server to resolve this problem.

UNSUPPFS, Unsupported file system structure

Explanation: An attempt was made to mount a DECdfs access point for a disk volume containing a file structure that is not supported by the version of OpenVMS running on the client system. For example, an OpenVMS Version 7.2 system might be serving an access point for an ODS-5 disk volume. DECdfs client systems running an earlier version of OpenVMS will fail to mount this access point due to lack of operating system support. This message has a severity level of Fatal.

User Action: None.

VFYCHAN, Failure verifying kernel channel

Explanation: An error occurred during initialization of the server process. This message has a severity level of Error.

User Action: Verify that the server is properly installed (as described in the installation guide). If the problem persists, report it.

XACT_OUT_RANGE, The value given for the transactions outstanding maximum is out of range

Explanation: The value specified for the maximum number of outstanding Communication Entity requests is outside the valid range. This message has a severity level of Error.

User Action: Repeat the operation, using an appropriate value. To display the range of correct values, use the DFSS\$CONTROL command SHOW COMMUNICATION/REQUESTS_OUTSTANDING_MAXIMUM.

Troubleshooting the DECdfs Environment

This appendix suggests ways to recover from difficulties encountered while operating DECdfs for OpenVMS. The following topics are covered in this appendix:

- What to do first (see Section B.1)
- Controlling event and error messages (see Section B.2)
- Using other DECdfs servers and clients to isolate problems (see Section B.3)
- Solving common DECdfs problems (see Section B.4)

B.1 What to Do First

If you encounter a problem using DECdfs, first try the following suggestions to correct the problem:

- Retry a procedure, reentering information if necessary, to eliminate possible mistakes in typing. Retrying a procedure may mean completely mounting a partially mounted device (see Section 3.4.6) or gaining access to a name server that has been updated more recently.
- If you are unsure of an access point name, you can check the access points registered in the Digital Distributed Name Service (DECdns) name space by entering the command `SHOW ACCESS_POINT`. DECdfs lists access points read from a DECdns server and if the local node is a DECdfs server from the DECdfs server's local database.
- Ensure that the DECdfs function you are trying to perform is not obsolete or restricted. Check the list of obsolete command parameters in Appendix D and the list of restrictions in the release notes.
- Ensure that you have the required privileges to perform the desired operation. Required privileges are listed with each applicable command described in Chapter 4.
- Observe the status of the server or Communication Entity by entering a `SHOW SERVER` or `SHOW COMMUNICATION` command. One or both entities may have stopped. See Section 2.9 for information about restarting the server and Communication Entity.
- If you receive an error message in response to a DECdfs operation, look up the error message in Appendix A and perform any user action included with the message.

Troubleshooting the DECdfs Environment

B.2 Controlling Event and Error Messages

B.2 Controlling Event and Error Messages

You can set the DECdfs server and Communication Entity to report various event and error messages to OPCOM and to an error log, or you can disable reporting of event and error messages altogether.

The DECdfs SET SERVER and SET COMMUNICATION commands have a /REPORTING qualifier that allows you to enable and disable reporting for server, communication, and network event and error messages. The /REPORTING qualifier also controls whether the DECdfs server sends messages to OPCOM. Figure B-1 shows the event and error message paths for the server and Communication Entity.

Note

Some messages, including normal startup and shutdown messages, startup failure messages, and checksum error messages appear even if reporting is disabled.

The DFSS\$CONFIG.COM file defines logical names DFSS\$ERROR_DEVICE and DFSS\$OUTPUT_DEVICE that allow you to specify a destination device or file for server and communication error messages. The default device for both the DFSS\$ERROR_DEVICE and DFSS\$OUTPUT_DEVICE is SYS\$MANAGER:DFSS\$ERROR.LOG.

Note

The server, Communication Entity, and client pass non-DECdfs error messages and the DECdfs Control Program (DFSCP) error messages to the interactive user's terminal.

When you first install DECdfs software, the DECdfs server and Communication Entity report messages to OPCOM. OPCOM is enabled by default with output to the system console. All DECdfs messages (except some that are always enabled) are disabled.

Figure B-1 Event and Error Message Paths

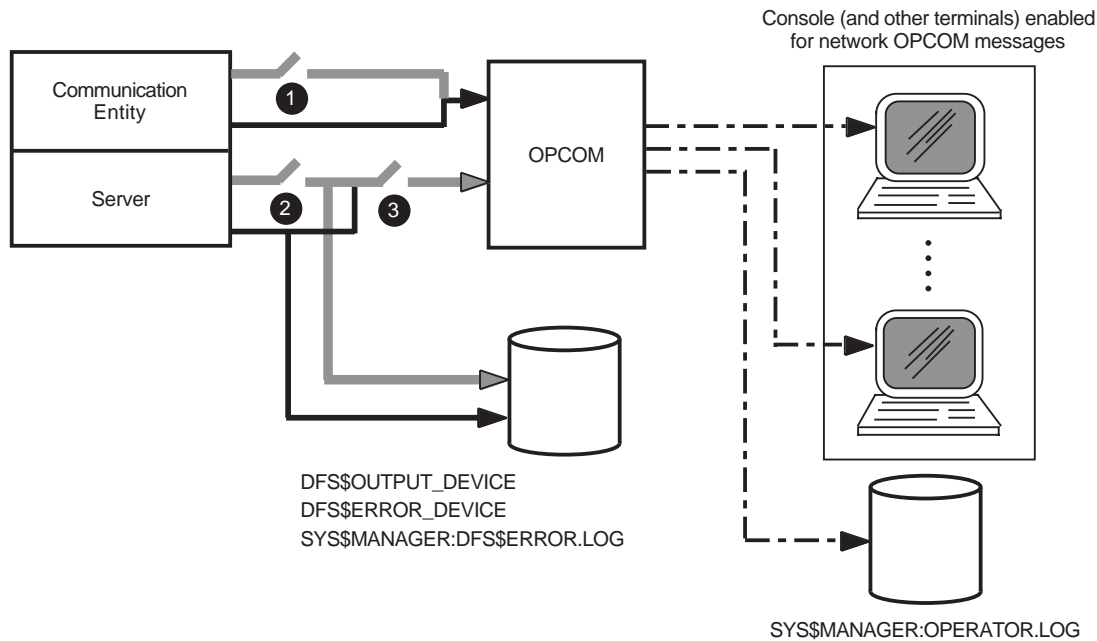

Commands that control messages:

- ① SET COMMUNICATION /REPORTING=[NO]ERRORS,[NO]NETWORK
- ② SET SERVER /REPORTING=[NO]ERRORS
- ③ SET SERVER /REPORTING=[NO]OPCOM

- ▶ Messages that can be disabled
- ▶ Messages that cannot be disabled
- - -▶ Messages that depend on OPCOM settings

ZK-5429A-GE

To permanently change the settings for DECdfs messages, edit the SYS\$STARTUP:DF\$CONFIG.COM file. You can change the logical name assignments for DF\$OUTPUT_DEVICE and DF\$ERROR_DEVICE. You can also change the settings for the /REPORTING qualifier to the SET SERVER and SET COMMUNICATION commands.

B.3 Using Other DECdfs Servers and Clients to Isolate Problems

You can identify the source of some DECdfs problems by using other DECdfs devices. For example, if you are having trouble reading files from a server disk, try gaining DECdfs access to another disk on another DECdfs server. If that operation succeeds, suspect difficulty with the server you cannot reach.

If you cannot gain access to any other DECdfs devices, suspect problems with the DECdfs client. To confirm a client problem, try gaining access to the DECdfs server device from another DECdfs client. Successful access from a different client suggests a problem with the original client.

Troubleshooting the DECdfs Environment

B.3 Using Other DECdfs Servers and Clients to Isolate Problems

If you suspect that a DECdfs server disk is not available, enter some other command directly on the server node, such as the OpenVMS DCL command `DIRECTORY`, to check disk and file availability. You can also try reading from the DECdfs server disk locally (from the server) to determine that the server's disks are operating correctly.

B.4 Solving Common DECdfs Problems

This section suggests actions you can take to solve some common DECdfs problems. You may also wish to consult Appendix F for information about restrictions on DECdfs support for Extended File Specifications.

B.4.1 DECdfs Fails After Upgrading from an Earlier Version

If DECdfs fails after upgrading from an earlier DECdfs version, reboot the system. This causes the software to start using new versions of DECdfs drivers and shareable images.

B.4.2 Unexpected Error While Opening a File

If you have problems opening a file, you might receive an error code. Table B-1 shows typical error codes you might encounter while opening one or more files and suggests possible causes of the errors.

Table B-1 Error Codes While Opening Files

Error Code	Possible Cause
RMS-E-DNR	DECnet or the Communication Entity is unavailable at the client, or the Communication Entity is unavailable at the server. A SYSTEM-F-DEVNOTMOUNT error code may appear in place of the RMS-E-DNR error code. Restart DECnet or the Communication Entity or both at the client or server.
SYSTEM-F-UNREACHABLE	DECnet is unavailable at the server. Restart DECnet and DECdfs at the server.
SYSTEM-F-NOLISTENER	The server is not running. Restart the server.
SS\$_INCVOLLABEL	The server is running but the access point is not in the server database. Add the access point at the server.

B.4.3 Unexpected Error While Accessing an Open File

If you receive an error code or other unexpected response while reading from or writing to an open file, the link might have disconnected or the server node might have failed.

The system returns an `SS$_ABORT` error code when such problems occur. The application or utility being used might return its own error code with the `SS$_ABORT` error code.

When DECdfs detects the loss of the server, DECdfs enters the mount verification state (see Section 3.4.5) and tries to reestablish the link. Reestablishing the link allows the next file-open operation to succeed.

B.4.4 Unexpected DECdns Errors when Performing Access Point Operations

When using DECdfs, you might encounter DECdns errors when adding, removing, mounting, or showing access points. You can avoid the most common problems with DECdns by making sure you have met the following DECdns needs:

- To add access points, the DECdfs server manager account requires write access to the DECdns directory where you want to add access points.
- To remove access points, the DECdfs server manager account must have write access to the DECdns directory where you want to remove access points and delete access to the DECdns object that represents the access point.
- To mount or show access points, the DECdfs server manager account or DECdfs client user account requires read access to the appropriate DECdns directories and object.
- Be certain you entered the access point name correctly. See the appropriate command examples in Chapter 4.

If you have all the required privileges and have entered the access point name correctly, you might still receive a DECdns error message. Use the Help Message utility to get more information about the error and perform the suggested recovery action. (For online help about Help Message, enter HELP HELP/MESSAGE at the DCL prompt (\$).)

Note

In some instances, you might receive an error message saying “Requested entry does not exist,” even though you are certain that the access point does exist. DECdns returns this message when you lack the necessary privileges to perform a requested operation. Check with the DECdns manager to ensure that you have the necessary privileges.

B.4.5 Problems Accessing Server Files

This section suggests ways to recover from problems in accessing server files.

B.4.5.1 New Client User Cannot Access Server Files

A new client user might not be able to access server files after proxy access is added at the server. Access attempts receive the “Insufficient privilege or file protection violation” error message.

Enter the SET SERVER /INVALIDATE_PERSONA_CACHE command on the server. This forces the persona cache to read fresh data from the NETPROXY.DAT, SYSUAF.DAT and RIGHTSLIST.DAT files without waiting for the persona cache update interval to expire.

B.4.5.2 Existing Client User Cannot Access Server Files

User attempts to access server files might result in an “Insufficient privilege or file protection violation” error message from the server.

Try the following actions to diagnose and correct the problem:

1. Enter the SHOW SERVER /USERS command on the server.

Troubleshooting the DECdfs Environment

B.4 Solving Common DECdfs Problems

Note

To get useful information, you must enter the `SHOW SERVER /USERS` command within the persona cache update interval that follows the unsuccessful client access.

Look for the following possible problems:

- If the client (remote node::user) is correct but the local user is `DFS$DEFAULT` when you expected the client to use an actual user account, be certain you added a default proxy by using the `AUTHORIZE` Utility's `ADD/PROXY` command:

```
$ RUN SYS$SYSTEM:AUTHORIZE
UAF> ADD /PROXY remote_node::remote_user local_user /DEFAULT
```

- If the client's node is a cluster member and the local user is `DFS$DEFAULT` when you expected the client to use an actual user account, be certain you enabled the alias outgoing on the cluster and added a default proxy for the cluster alias by using the `AUTHORIZE` Utility's `ADD/PROXY` command:

```
UAF> ADD /PROXY cluster_alias::remote_user local_user /DEFAULT
```

If the outgoing cluster alias cannot be enabled for some reason, be certain you added a default proxy for each cluster member by using the `AUTHORIZE` Utility's `ADD/PROXY` command:

```
UAF> ADD /PROXY cluster_member::remote_user local_user /DEFAULT
```

Note

If a DECdfs client cannot find the target proxy account and the server does not have a `DFS$DEFAULT` account, the `SHOW SERVER /USERS` command will not produce information about the failed access. In this case, you can create a `DFS$DEFAULT` account on the server to aid in diagnosing the problem. Then retry step 1.

2. Enter the `SHOW COMMUNICATION /CURRENT_CONNECTIONS` command on the server.

Look for the following possible problems:

- The client node is a cluster member, and you see an incoming connection from the client node name, but the proxy is for the cluster alias.

To use the cluster alias in the proxy, add the following commands to the `DFS$SYSTARTUP.COM` file on the client node:

DECnet Phase IV:

```
$ MCR NCP SET OBJECT DFS$COM_ACP ALIAS OUTGOING ENABLED
```

Troubleshooting the DECdfs Environment

B.4 Solving Common DECdfs Problems

DECnet Phase V:

```
$ MCR NCL CREATE [NODE node-id] SESSION CONTROL APPLICATION DFS$COM_ACP
$ SET [NODE node-id] SESSION CONTROL DFS$COM_ACP OUTGOING ALIAS TRUE
```

Compaq assumes the executor alias node name is already defined on the client node. Otherwise, add proxies for the cluster member node names.

- The client node is a cluster member, and you see an incoming connection from the client's cluster alias, but the proxy is for the client cluster member name.

Add a proxy for the cluster alias or disable the outgoing alias on the client node's DFS\$COM_ACP object.

- You see an incoming connection from the the client node, but it is displayed as a numeric DECnet address instead of the node name.

Make sure the client node is correctly defined in the server node's DECnet node database. If you load the node database in a batch job on the server, make sure DECdfs does not start on the server before all the client nodes are defined on the server.

Note

If you add or modify any proxies, remember to enter the SET SERVER /INVALIDATE_PERSONA_CACHE command before using the new proxy information.

B.4.6 Problems Printing Server Files

You must use the /SYSTEM qualifier with the MOUNT command when you mount an access point. Otherwise, just as with non-DECdfs disks, the print symbiont cannot access the device. See Section 3.6 for information about using the /SYSTEM qualifier.

On clients that are clusters, you also must ensure that DECdfs device names are consistent on all cluster members. Use the /DEVICE qualifier to the MOUNT command to force the same device name onto each cluster member. See Section 3.6 for information about using the /DEVICE qualifier.

The print symbiont runs under the system account. One of the following conditions must apply to enable users to print files:

- The SYSTEM account on the client needs proxy access to the special printing account on the server (see Section 2.2.4).
- The SYSTEM account on the client needs proxy access to the user account on the server.
- The file must be readable by the DFS\$DEFAULT account on the server.

If the client is a cluster and the cluster alias is enabled, the proxy must be from *CLUSTER-ALIAS-NAME::SYSTEM*. If the cluster alias is not enabled, add proxies on the server from each *CLUSTER-MEMBER-NAME::SYSTEM*. See Section 2.2.4 for information on adding proxies.

Troubleshooting the DECdfs Environment

B.4 Solving Common DECdfs Problems

Note

When you add or modify a proxy, DECdfs might not recognize it until the persona cache updates. You can force the persona cache to read the new proxy immediately by entering the `SET SERVER/INVALIDATE_PERSONA_CACHE` command.

B.4.7 Problems Backing Up Server Files

If you experience difficulty in using DECdfs to back up files, make certain you are not using the `/IMAGE`, `/PHYSICAL`, or `/FAST` qualifiers with the `BACKUP` command.

Adjusting DECnet and Client RMS Parameters to Enhance Performance

Compaq designed DECdfs software to provide excellent performance using the default DECnet parameters. For this reason, many DECdfs users do not need to change any DECnet parameters.

In some configurations, however, you can significantly improve performance by adjusting a few DECnet parameters (called tuning). For example, a programming environment in which each individual client user opens many files simultaneously could benefit from tuning. Such an environment uses more network resources than one in which each client user opens only one file at a time. The more network resources your configuration uses, the more likely it is to benefit from tuning. Another DECdfs environment in which tuning can improve performance is a server or client system that supports many DECdfs users. This appendix describes the DECnet parameters you can adjust to tune your DECdfs configuration to suit your needs. For detailed information on DECnet parameters, see the DECnet Phase IV or DECnet Phase V documentation set, depending on the version of DECnet you are using.

C.1 Setting DECnet Network Parameters

To obtain the greatest benefit, adjust parameters that affect many users. Tune the server first and then clients with the highest number of DECdfs users. You can change a DECnet parameter both temporarily and permanently. It is useful to change it temporarily in order to evaluate the effect of the change. When you are satisfied with the change, you can make it permanent.

DECnet Phase IV:

Use the Network Control Program (NCP) SET command to modify DECnet network parameters temporarily. The SET command affects the volatile database. Parameters changed with SET take effect immediately but are lost when the system shuts down. The DEFINE command affects the permanent database. Parameters set with DEFINE do not take place until the system reboots but are permanent thereafter unless you change them. For more information about NCP commands, see *DECnet for OpenVMS Network Management Utilities*.

DECnet Phase V:

To change a parameter so that the new value takes effect immediately, enter the appropriate command at the prompt NCL>. Changes made by this method take effect immediately but are lost when the system shuts down. This method is useful in testing the immediate effect of various parameter settings.

To permanently change a DECnet Phase V parameter, edit the applicable NCL script file. The names of NCL script files have the following format: SYSSMANAGER:NET\$entity-module_STARTUP.NCL. Changes entered in the NCL script file do not take effect until the system reboots but are permanent

Adjusting DECnet and Client RMS Parameters to Enhance Performance

C.1 Setting DECnet Network Parameters

thereafter unless you change them. Use this method when you want to preserve your changes. See the <REFERENCE>(DNPLUS_OVMS_NET_MGMT), *DECnet/OSI Network Management*, <REFERENCE>(DNPLUS_NCL_REF), and the *DECnet/OSI Network Control Language Reference* manuals for more information about setting DECnet Phase V parameters.

The same procedure for setting network parameters applies to DECdfs servers and clients. The following sections describe how to adjust network parameters that affect the performance of DECdfs.

C.1.1 Line Receive Buffers/Station Buffers

Line receive buffers (called *station buffers* in DECnet Phase V) enable DECdfs to receive information from the network. DECdfs operates efficiently when enough buffers are available to accept incoming data. If the number of buffers available is not sufficient, incoming data is lost and the network must retransmit it, thus degrading performance. DECnet counts the number of times the network attempts to transmit information and finds that a buffer is unavailable. You can display the total as follows:

DECnet Phase IV:

```
NCP> SHOW LINE line-id COUNTERS
```

The number of times a buffer was unavailable is shown at the end of the display as *User buffer unavailable*.

DECnet Phase V:

```
NCL> SHOW [NODE node-id] CSMA-CD STATION station-name ALL COUNTERS
```

Replace *node-id* with the name or address of the node. The number of times a buffer was unavailable is shown at the end of the display as *Station buffer unavailable*. (To show the name of the station, use the command SHOW CSMA-CD STATION * ALL COUNTERS.)

You can increase the number of buffers, as follows:

DECnet Phase IV:

```
NCP> SET LINE line-id RECEIVE BUFFERS integer
```

Replace *integer* with a value from 1 to 32. The default value is 4.

The following example uses the NCP SET and DEFINE commands to set the number of receive buffers for the line BNA-0 to 26.

```
NCP> SET LINE bna-0 RECEIVE BUFFERS 26  
NCP> DEFINE LINE bna-0 RECEIVE BUFFERS 26
```

DECnet Phase V:

```
NCL> SET NODE 0 CSMA-CD STATION station-name STATION BUFFERS integer
```

Replace *integer* with a value between 1 and 64. The default is 4.

The following example sets the number of station buffers for station SVA-0 to 23.

```
NCL> DISABLE NODE 0 CSMA-CD STATION sva-0  
NCL> SET NODE 0 CSMA-CD STATION sva-0 STATION BUFFERS 23  
NCL> ENABLE NODE 0 CSMA-CD STATION sva-0
```

To make your change permanent, edit the file SYS\$MANAGER:NET\$CSMACD_STARTUP.NCL. Edit the line with the following format to specify the number of station buffers:

```
NCL> SET NODE 0 CSMA-CD STATION station-name STATION BUFFERS integer
```

Adjusting DECnet and Client RMS Parameters to Enhance Performance

C.1 Setting DECnet Network Parameters

C.1.2 Pipeline Quota (DECnet Phase IV Only)

The NCP PIPELINE QUOTA parameter specifies the number of bytes of nonpaged pool each DECnet logical link has available for buffering data between DECnet and DECdfs. DECdfs uses a single DECnet logical link between a client and server node. If a node has many concurrent users, this logical link may need more nonpaged pool than the default of 3000 bytes.

If both a client-server and server-client relationship exist between two nodes, one DECnet logical link exists for each of the two relationships. Hence, the pipeline quota you set must support the larger of two numbers representing:

- The client traffic between one node and the other node.
- The server traffic between one node and the other node.

To set the PIPELINE QUOTA parameter, use the following command:

```
NCP> SET EXECUTOR PIPELINE QUOTA quota
```

For optimal system performance with moderate to heavy DECdfs workloads, replace *quota* with 32767. If many DECdfs users on one client access a server, replace *quota* with its maximum value of 65535.

C.1.3 Maximum Window (DECnet Phase V Only)

The MAXIMUM WINDOW parameter replaces the DECnet PIPELINE QUOTA parameter. MAXIMUM WINDOW is a Network Services Protocol (NSP) and Open Systems Interconnection (OSI) characteristic. It controls the number of data segments allowed to be transmitted over a transport connection before at least one acknowledgment must be returned from the destination system, such as DECdfs. If the number of data segments transmitted equals the MAXIMUM WINDOW value and no acknowledgments have been received, the transport stops sending data segments and waits for an acknowledgment message. For further information on MAXIMUM WINDOW, see the DECnet Phase V documentation set.

To determine the value set for MAXIMUM WINDOW on your system, use the following command:

```
NCL> SHOW NSP ALL
```

To set the MAXIMUM WINDOW parameter on an NSP transport, use the following commands:

```
NCL> DISABLE [NODE node-id] NSP
NCL> SET [NODE node-id] NSP MAXIMUM WINDOW = integer
NCL> ENABLE [NODE node-id] NSP
```

Replace *node-id* with the name or address of the node. Replace *integer* with a value between 1 to 2047. The default value is 32. Compaq recommends a value of 60 for configurations with an average number of users, and up to 120 to 150 for configurations with a large number of users.

To make your change permanent, edit the file named in the following format: SYSSMANAGER:NET\$transport-name_STARTUP.NCL. *Transport-name* can be either NSP or OSI. DECnet nodes use NSP, but both NSP and OSI reside on DECnet Phase V nodes. Edit the line with the following format to specify the value for *integer*.

```
SET NODE 0 NSP MAXIMUM WINDOW = integer
```

Adjusting DECnet and Client RMS Parameters to Enhance Performance

C.1 Setting DECnet Network Parameters

C.1.4 Maximum Links/Transport Connections

The NCP `MAXIMUM LINKS` and NCL `MAXIMUM TRANSPORT CONNECTIONS` parameters specify how many connections a node can maintain with other nodes.

DECnet Phase IV:

`MAXIMUM LINKS` determines how many DECdfs connections a server accepts from DECdfs clients. Each communication connection between a client and a server requires a single DECnet logical link (transport connection). The DECdfs Communication Entity creates one connection for all communication between a server and a particular client. This single connection provides DECdfs service to any number of users at the client. The users can mount any number of access points on the server and open any number of files.

To specify how many transport connections your system allows, use the following command:

```
NCP> SET EXECUTOR MAXIMUM LINKS integer
```

The maximum value for *integer* is 960. This value is reduced to 512, however, if the `ALIAS MAXIMUM LINKS` parameter is also specified. The default value is 32. A workable range for many networks is 25 to 50.

The maximum should be high enough to accommodate both DECdfs and all other network users. You may need to raise this parameter on servers with incoming connections from many different clients and on clients with outgoing connections to many different servers.

The following example sets the `MAXIMUM LINKS` to 40:

```
NCP> SET EXECUTOR MAXIMUM LINKS 40
NCP> DEFINE EXECUTOR MAXIMUM LINKS 40
```

DECnet Phase V:

`MAXIMUM TRANSPORT CONNECTIONS` determines how many DECdfs connections a server accepts from DECdfs clients. Each communication connection between a client and a server requires a single DECnet logical link (transport connection). To determine the value set for `MAXIMUM TRANSPORT CONNECTIONS`, use the following command:

```
NCL> SHOW NSP ALL
```

To modify the maximum transport connections parameter, disable the transport, set the parameter for the transport, and reenables the transport, use the following commands:

```
NCL> DISABLE NODE [node-id] NSP
NCL> SET NODE [node-id] NSP MAXIMUM TRANSPORT CONNECTIONS integer
NCL> ENABLE NODE [node-id] NSP
```

Replace *node-id* with the name or address of the node. Replace *integer* with a value between 0 and 65535. The value must be less than the current value of `MAXIMUM REMOTE NSAPS`. For further information on `MAXIMUM REMOTE NSAPS`, see the *DECnet/OSI Network Control Language Reference* manual or the `<REFERENCE>(DNPLUS_NCL_REF)` manual.

The following example sets the maximum transport connections parameter for an NSP protocol to 1001.

Adjusting DECnet and Client RMS Parameters to Enhance Performance

C.1 Setting DECnet Network Parameters

```
NCL> DISABLE NODE 0 NSP
NCL> SET NODE 0 NSP MAXIMUM TRANSPORT CONNECTIONS 1001
NCL> ENABLE NODE 0 NSP
```

To make your change permanent, edit the script file `SYSS$MANAGER:NET$transport-name_STARTUP.NCL`. The transport name can be either NSP or OSI. Edit the line with the following format to specify the value for the maximum transport connections parameter:

```
SET NODE 0 NSP MAXIMUM TRANSPORT CONNECTIONS integer
```

C.2 Setting Client RMS Default Parameters

If you use the file processing and management functions of VAX Record Management Services (RMS), you may need to adjust the RMS defaults. Note that RMS buffering occurs on the DECdfs client.

Section C.2.1 describes how to set RMS parameters for sequential file access. Section C.2.2 suggests an RMS default for indexed sequential files or relative files that are heavily accessed. For more information about the `SET RMS_DEFAULT` command, see the *HP OpenVMS DCL Dictionary*. For more information about optimizing access to RMS files, see *Guide to OpenVMS File Applications*.

C.2.1 Sequential File Access

To make the best use of DECdfs's quick file access, most applications benefit from default RMS multibuffer and multiblock values of 3 and 16, respectively, when accessing sequential files.

Set the number of buffers to 3 for the most efficient multibuffering of file operations. Use the following DCL command:

```
$ SET RMS_DEFAULT/BUFFER_COUNT=3 /DISK
```

Next, set the size of each buffer to sixteen 512-byte blocks:

```
$ SET RMS_DEFAULT/BLOCK_COUNT=16
```

To set these values for just your user process, you can include the commands in your `LOGIN.COM` file. To set them on a systemwide basis, you can add the `/SYSTEM` qualifier and include the commands in the `DFSS$SYSTARTUP` file.

RMS multibuffer and multiblock values that are larger than the default values can slow performance by allowing the application to exceed the DECnet pipeline quota. However, these values are recommendations that may not be optimal for every application. If your application opens many files or if it has a small working set size, you may find these values are too large.

Note

If you prefer, you can set the RMS default multibuffer value by using the `SYSGEN` parameter `RMS_DFMBF`. You can set the RMS default multiblock value by using the `SYSGEN` parameter `RMS_DFMBBC`.

Adjusting DECnet and Client RMS Parameters to Enhance Performance

C.2 Setting Client RMS Default Parameters

C.2.2 Indexed Sequential File or Relative File Access

If you have indexed sequential files or relative files that are heavily accessed, you may set appropriate RMS defaults by using the `/INDEXED` or `/RELATIVE` qualifiers to the `SET RMS_DEFAULT` command.

This manual cannot recommend specific values for `/INDEXED` or `/RELATIVE` qualifiers to use with DECdfs because these values depend on file characteristics and file access patterns that can vary widely. For information about determining appropriate values for the `/INDEXED` or `/RELATIVE` qualifiers, see the *Guide to OpenVMS File Applications*.

Do not use the `/INDEXED` OR `/RELATIVE` qualifier if typical file access patterns from the client involve only a few record operations each time an indexed sequential or relative file is opened.

If several processes share read access to a DECdfs-served file, try using global buffering for that file. For more information about global buffering, see the *Guide to OpenVMS File Applications*.

Note

If you prefer, you can set the RMS default multibuffer count for indexed sequential files value by using the SYSGEN parameter `RMS_DFIDX`. You can set the RMS default multibuffer count for relative files value by using the SYSGEN parameter `RMS_DFREL`.

Obsolete Command Qualifiers and Configuration Logicals

To simplify DECdfs operation, Compaq removed some qualifiers that were present in earlier versions of DECdfs, as follows:

- SET COMMUNICATION /SESSIONS_MAXIMUM
- SET COMMUNICATION /CONNECTIONS_MAXIMUM
- SET SERVER /FILES_MAXIMUM
- SET SERVER /PERSONA_CACHE=blocks_threshold

If you attempt to use an obsolete qualifier, DECdfs accepts the command but does not set the requested qualifier. DECdfs does not return an error message with any obsolete qualifiers except for SET SERVER /PERSONA_CACHE=blocks_threshold.

Note

Removing the /SESSIONS_MAXIMUM and /CONNECTIONS_MAXIMUM command qualifiers eliminates limitations set by these qualifiers. However, the following DECnet commands limit the number of connections:

For DECnet Phase IV:

```
NCP> SET/DEFINE EXECUTOR MAXIMUM LINKS integer
```

For DECnet Phase V:

```
NCL> SET NODE [node-id] NSP MAXIMUM TRANSPORT CONNECTIONS integer
```

Compaq also removed two logicals from DFSS\$CONFIG.COM, as follows:

- DFSSPQL_FILLM
- DFSSPQL_BYTLM

If you accidentally define these logicals, DECdfs ignores them.

Information for Programmers

The OpenVMS operating system includes functions that allow users and programs to determine whether a device is a DECdfs client device.

The following example shows how to determine whether a disk is a DECdfs client device by using a DCL procedure. The procedure returns “TRUE” for a DECdfs client device and “FALSE” for a non-DECdfs client device, as follows:

```
$ RUN SYS$SYSTEM:DFS$CONTROL
DFS> MOUNT .FIN.ADMIN.DIV.WILMER DFS_DISK
DFS> EXIT
$ IS_IT_DFS_CLIENT = F$GETDVI ("DFS_DISK", "DFS_ACCESS")
$ SHOW SYMBOL IS_IT_DFS_CLIENT
  SYMBOL IS_IT_DFS_CLIENT == "TRUE"
$
```

You can determine if DECdfs has been started on the system by checking for the existence of the communications device, DFSRR0. The following lexical function returns a value of True if the communications driver has been loaded:

```
F$GETDVI ("DFSRR0", "EXISTS")
```

If this call returns False, neither the client nor the server is active. A similar call that specifies device DFSS0 will determine if the DECdfs server driver has been loaded.

You can also write your own program code. If you need to identify a DECdfs client device in a program, you can use a similar \$GETDVI macro call specifying DVIS_DFS_ACCESS as the item code.

The following example shows another way to determine whether a disk is a DECdfs client device. The example uses the C programming language and the SYS\$GETDVIW system service routine.

Information for Programmers

```
/*
 * Example program to say if the specified device is a DFS-served device.
 * The first command line arg is checked.
 */
#include <stdio.h>
#include <stdlib.h>
#include <sdef.h>
#include <starlet.h>
#include <descrip.h>
#include <string.h>
#include <dvidf.h>

/* Item list structure definition. */
struct item_list {
    unsigned short int length; /* Item buffer length */
    unsigned short int code; /* Item code */
    void *address; /* Item buffer address */
    long *retlen; /* length returned */
    long termin; /* terminator */
};

long device_stat;

int main (int argc, char *argv[])
{
    long status; /* system service return status */
    $DESCRIPTOR (devname, ""); /* descriptor for device name */
    struct item_list ilist = {
        4,
        DVI$DFS_ACCESS, /* item list code */
        &device_stat, /* ptr to returned value */
        0,
        0
    };

    devname.dsc$a_pointer = argv[1]; /* descriptor points to first arg */
    devname.dsc$w_length = strlen (argv[1]);

    status = sys$getdviw (
        0,
        0,
        &devname,
        &ilist,
        0, 0, 0, 0);

    if (status != SS$NORMAL)
        exit (status); /* unknown device, etc. */
    if (device_stat)
        printf ("true\n");
    else
        printf ("false\n");
    exit (1);
}
```

The DECdfs access flag is also maintained in the DEVCHAR2 item. To modify the previous program to test that flag:

1. **Add:** #include <devdef.h>
2. **Change the item list code to:** DVI\$_DEVCHAR2
3. **Change the test of the return value to:** if (device_stat & DEV\$_DFS)

Restrictions on Extended File Specifications Support

OpenVMS Version 7.2 implements Extended File Specifications, which consists of two major components:

- A new, optional, volume structure, ODS-5, which provides support for names that are longer and have a greater range of legal characters than previous versions of OpenVMS
- Support for deep directories

DECdfs for OpenVMS Version 2.3 provides support for Extended File Specifications and ODS-5 volumes, with certain restrictions outlined in this appendix.

For more information on Extended File Specifications and ODS-5 volumes, refer to the *OpenVMS Guide to Extended File Specifications* in the OpenVMS Version 7.2 documentation set.

F.1 Requirements for Mounting DECdfs Access Points on an ODS-5 Volume

Only OpenVMS Alpha Version 7.2 systems running DECdfs Version 2.3 are capable of serving and mounting access points on ODS-5 volumes. If a pre-Version 7.2 client running DECdfs Version 2.3 attempts to mount a DECdfs access point on an ODS-5 volume, the operation fails with the following error:

```
%DFS-F-UNSUPPFS, Unsupported file system structure
```

A client system running an older version of DECdfs fails with a different error on an attempt to mount or access an ODS-5 access point, as follows:

```
%SYSTEM-E-UNSUPPORTED, unsupported operation or function
```

On OpenVMS VAX Version 7.2 systems, you can mount DECdfs access points on ODS-5 volumes, but you are limited to ODS-2-compliant file operations.

You can determine whether a mounted DECdfs access point is associated with an ODS-5 volume by executing a SHOW DEVICE/FULL command and checking the ODS-5 characteristic in the resulting volume status display. From a DCL command procedure, the F\$GETDVI lexical function returns the string F11V5 for the ACPTYPE argument. The \$GETDVI system service returns the value DVISC_ACP_F11V5 for the item code DVIS_ACPTYPE.

Restrictions on Extended File Specifications Support

F.2 XQP Programming Considerations

F.2 XQP Programming Considerations

DECdfs functions as a layer between OpenVMS Record Management Services (RMS) and the OpenVMS XQP file system. DECdfs accepts I/O requests from RMS on the client system and sends the I/O request information over a DECnet connection to the DECdfs server. The server takes the request and builds an equivalent I/O request for the XQP file system on the server and returns the results.

Since the DECdfs server and client systems can have different CPU architectures and may be running different versions of OpenVMS, compatibility issues can arise between the version of RMS on a DECdfs client and the version of XQP on the DECdfs server. One goal of DECdfs is to transparently handle any differences between systems in order to provide the expected result.

When the DECdfs client system is running an earlier version of OpenVMS than the DECdfs server, there are few compatibility issues because the XQP has maintained excellent upward compatibility from one release to the next. However, when the DECdfs client is running a later version of OpenVMS than the DECdfs server, there are compatibility issues to consider. For example, the Extended File Specifications support introduced with OpenVMS Version 7.2 creates certain problems when a DECdfs client running OpenVMS Version 7.2 accesses volumes served by a DECdfs server running an earlier version of OpenVMS.

F.2.1 File Naming and Format Changes

DECdfs Version 2.3 fully supports Extended File Specifications at the \$QIO interface of the Files-11 XQP when both the client and server systems are running OpenVMS Version 7.2. This includes 8- and 16-bit character set formats.

When you access files on an ODS-5 volume from an OpenVMS VAX Version 7.2 system, no escaped file name forms are returned. For an ODS-2 or ISO Latin-1 file format, the name stored in the file header is returned. For a UCS-2 file format, a pseudonym is returned, followed by the file identifier in parentheses.

When the DECdfs client system is running OpenVMS Version 7.2 and the DECdfs server system is running an earlier version of OpenVMS, file names are limited to ODS-2-compatible formats and character sets.

F.2.2 Wildcards in File Specifications

Historically, OpenVMS has used the percent sign (%) as the single-character wildcard in file specifications. The OpenVMS Version 7.2 XQP also recognizes the question mark (?) as an additional single-character wildcard. DECdfs Version 2.3 automatically replaces all question marks with percent signs if the access point being addressed is served by a pre-Version 7.2 system *unless* the FIB\$V_PERCENT_LITERAL flag is set. In this case, a SSS_BADFILENAME error status will be returned.

F.2.3 Modified XQP Attributes

ATR\$C_ASCNAME

The ATR\$C_ASCNAME attribute allows the file specification stored in a file's primary file header to be read and written. In OpenVMS Version 7.2, the maximum buffer size that can be specified has been increased from 86 to 252. If the DECdfs server system is running an older version of OpenVMS, the limit is still 86 bytes. In that case, a Version 7.2 client system can specify a larger buffer, but DECdfs automatically truncates it to 86 bytes before sending the request to the server.

Restrictions on Extended File Specifications Support F.2 XQP Programming Considerations

As stated in the *OpenVMS Guide to Extended File Specifications*, the ability to write this attribute is provided solely to permit compatibility with existing applications. New and modified programs should not write this attribute. Changing its value can prevent a file from being permanently deleted.

ATR\$C_FILE_SPEC

ATR\$C_FILE_SPEC is a read-only attribute that returns the physical file specification. In OpenVMS Version 7.2, the largest permitted buffer that can be specified has increased from 512 to 4098 bytes. On ODS-2 volumes, the attribute is returned as always. If the DECdfs server is running a version of OpenVMS prior to Version 7.2 and the client system is running OpenVMS Version 7.2, DECdfs automatically truncates any buffer larger than 512 bytes.

A

- /ABORT qualifier, 4-5
- Access control list
 - See ACL
- Access point, 1-4
 - adding, 2-8 to 2-11, 4-3
 - at a master file directory, 2-8
 - at a subdirectory, 2-9
 - changing, 2-14
 - dismounting, 4-5
 - finding, 2-14
 - mounting, 3-2 to 3-3, 4-8
 - alternative names, 3-3
 - naming conventions, 2-11
 - relationship with client device (figure), 1-5
 - removing, 2-14, 4-11
- /ACCESS_POINT qualifier, 4-20
- /ACCESS_POINTS_MAXIMUM qualifier, 4-15, 4-25
- ACL
 - attempts to modify or view, 2-16, 3-5
 - identifiers for DECdfs users, 2-16
 - using on server, 2-6
- /ACTIVE_FILES qualifier, 4-25
- ADD ACCESS_POINT command (DFSSCONTROL), 4-3
 - on systems with DECdns, 2-10
 - on systems without DECdns, 2-12
- /ALL qualifier
 - SHOW CLIENT command, 4-20
 - SHOW COMMUNICATION command, 4-22
 - SHOW SERVER command, 4-25
- ATRSC_ASCNAME attribute, F-2
- ATRSC_FILE_SPEC attribute, F-3

B

- Backup
 - client device results, 3-9
 - including nested subdirectories at server, 2-10
- Batch jobs
 - submitting from a cluster node, 3-10
- /BLOCK_COUNT qualifier (RMS), C-5
- /BRIEF qualifier, 4-17

- Buffer count
 - data cache
 - See Data cache
 - RMS, C-5
- /BUFFER_COUNT qualifier (RMS), C-5
- /BUFFER_SIZE qualifier, 4-12, 4-22

C

- C program example, E-1
- Cache
 - DECdfs
 - See also Data cache, Persona cache, 2-16
 - RMS, C-5
 - /CACHE_BUFFERS=COUNT_OF_BUFFERS qualifier, 4-26
 - /CACHE_BUFFERS=FILE_BUFFER_QUOTA qualifier, 4-26
- CHANNELCNT parameter (SYSGEN), 2-2
- Checksum comparison (DECdfs), 3-8
- /CHECKSUM qualifier, 3-8, 4-12, 4-22
- Client, 1-7, 3-1
- Client device, 1-5
 - backing up files to and from, 3-9
 - counters, 3-4
 - creating, 3-2, 4-8
 - data checking for, 3-3
 - hiding nested subdirectories at server, 2-10
 - information on, 3-3
 - logical name for, 3-2
 - mount verification, 3-7
 - programmer's information, E-1
 - unit numbers for, 3-2
 - volume name for, 3-2, 4-9
- Client-server relationship, 1-3
- Cluster alias, 3-9 to 3-10
 - outgoing from client, 3-9
- /CLUSTER_ALIAS qualifier, 4-3
- CMS libraries
 - needing consistent timestamps, 1-9
 - needing logical names, 1-9
 - reserving and replacing components, 2-6
 - storing, 1-3
- Command files
 - using DFSSCONTROL commands in, 1-13

Communication Entity, 1-7
connections on server, 2-3, C-4
requests from clients allowed on server, 2-2

Connection DECdfs
relationship to logical link, 1-8, 2-3
resulting from display of access points, 1-8

Counters
client, 3-4
persona cache (table), 2-17, 2-19

/COUNTERS qualifier, 4-25
SHOW CLIENT command, 4-20
SHOW COMMUNICATION command, 4-22

CREATE ALIAS command (NCL), 3-10
CREATE ALIAS PORT command (NCL), 3-10
CREATE SESSION CONTROL APPLICATION
command (NCL), 2-15, 3-10, B-7

/CURRENT_CONNECTIONS qualifier, 4-22

D

Data cache, 2-18 to 2-20
displaying counters of, 2-19
number of buffers in, 4-15
per-file quota of, 2-19
size of, 2-18, 4-15

Data check
compared with checksum comparison, 3-8
on DFSC device, 3-3, 4-9

/DATA_CACHE=COUNT_OF_BUFFERS qualifier,
4-15

/DATA_CACHE=FILE_BUFFER_QUOTA qualifier,
4-15

/DATA_CHECK qualifier, 3-3, 4-8

DCL procedure, E-1

DDIF files, 3-5

DECdns, 1-3
consistency with current information, 2-15
relationship to DECdfs, 1-3

DECnet
consequences of stopping, 3-11

DECnet parameters
adjusting, C-1

Default account for DECdfs
See DFSS\$DEFAULT account, 2-3

DEFINE EXECUTOR command (NCP)
ALIAS NODE parameter, 3-9

DELETE SESSION CONTROL PORT command
(NCL), 4-13

/DEVICE qualifier, 3-2, 3-9, 4-9

DFSS\$CONFIG.COM file, 1-13

DFSS\$CONTROL commands, 1-12, 4-1 to 4-37
See also command names
in DECdfs system command files, 1-13
interactive use, 1-14
table, 1-12

DFSS\$DEFAULT account, 2-3
for printing files, 2-7

DFSS\$DEFAULT_NAMESPACE, 2-13

DFSS\$SERVICE identifier, 2-16

DFSS\$STARTUP.COM file, 1-13

DFSS\$SYSTARTUP.COM file, 1-13

DFSC device
See Client device

Digital Distributed Name Service
See DECdns

DIRECTORY command (DCL)
display of UICs, 3-5

DISCONNECT LINK command (NCP), 4-13

DISMOUNT command (DFSS\$CONTROL), 4-5

DVI\$DFS_ACCESS item code, E-1

E

ENABLE NODE ALIAS PORT command (NCL),
3-10

Error codes
See Messages

Error conditions
reporting, 3-6

/ERROR qualifier, 4-34
START SERVER command, 4-35

Executor node parameters
See SET | DEFINE EXECUTOR command
(NCP)

EXIT command (DFSS\$CONTROL), 4-6

Extended File Specifications
ATRSC_ASCNAME attribute, F-2
ATRSC_FILE_SPEC attribute, F-3
file naming and format changes, F-2
mounting access points on ODS-5 volumes, F-1
restrictions, F-1
wildcards in file specifications, F-2
XQP programming restrictions, F-2

F

Files
access to, 2-5, 2-16

Free block reporting, on DFSC device, 3-3

/FREE_BLOCKS qualifier
SHOW CLIENT command, 4-20

/FULL qualifier
SHOW ACCESS_POINT command, 4-17

G

\$GETDVI lexical function, E-1

/GROUP qualifier, 4-9

H

HELP command (DFSSCONTROL), 4-7
Help on DECdfs, 1-14, 4-7

I

/INDEXED qualifier (RMS), C-6
/INVALIDATE_PERSONA_CACHE qualifier,
2-17, 4-15

K

Known image, 1-2

L

Link
 disconnecting, 4-13
/LOCAL qualifier, 4-18
 ADD ACCESS_POINT command, 4-3
 REMOVE ACCESS_POINT command, 4-11
Logical I/O, 1-2
Logical link
 defined, C-4

M

Mapped sections, 1-2
MAXIMUM LINKS parameter (NCP)
 server considerations, C-4
/MESSAGE qualifier, 4-9
Messages
 DECdfs, 3-6, A-1 to A-26
 mount verification (table), 3-8
MONITOR RMS DCL command, 3-6
MOUNT command (DFSSCONTROL), 1-5, 3-2,
4-8
 /DEVICE qualifier, 3-10
 in cluster systems, 2-12
 on systems without DECdns, 2-12
Mount verification, 3-7
Mounting an access point
 See Access point, mounting
Multiblock value (RMS) for client, C-5
Multibuffering value (RMS) for client, C-5

N

Namespace (DECdns), 1-4
NCL parameters
 MAXIMUM TRANSPORT CONNECTIONS,
 C-4
 MAXIMUM WINDOW, C-3
 STATION BUFFERS, C-2

NCP parameters

 MAXIMUM LINKS, C-4
 PIPELINE QUOTA, C-3
 RECEIVE BUFFERS, C-2
NETWORK identifier, 2-16
/NODE qualifier, 4-9
 SHOW ACCESS_POINT command, 4-18
 SHOW CLIENT command, 4-20
NPAGEDYN parameter (SYSGEN)
 modified for client, 3-1

O

Obsolete logicals, D-1
Obsolete qualifiers, D-1
ODS-5 volumes
 mounting access points on, F-1
OPCOM messages
 See also /REPORTING qualifier
 mount verification, 3-7
OpenVMS Cluster systems
 client, 3-2, 3-9 to 3-10
 server
 mounting the access points of, 3-3
OpenVMS file access and DECdfs, 1-9
/OUTPUT qualifier, 4-34
 START SERVER command, 4-35

P

Page files, 1-2
Performance
 enhancing, C-1
Performance of DECdfs node, 2-2, 2-18, 3-1, 3-8
Persona cache, 2-16 to 2-18
/PERSONA_CACHE qualifier, 4-16
/PERSONA_CACHE=UPDATE_INTERVAL
 qualifier, 2-17, 4-26
Physical I/O, 1-2
Prefetching, 2-18, 2-20
Print symbiont, B-7
Printing files
 access needed at server, 2-7
 from a cluster node, 3-10
 from client requests, 3-5
 MOUNT command qualifiers, 3-9
 server, B-7
Privileges, 2-5
Programmer's information, E-1
Proxy
 accounts
 creating, 2-3
 for client print requests, 2-7
 required by client, 3-5
 UICs for, 2-5
 outgoing from client, 3-10

Q

QIO interface, 1-2

R

/READS_MAXIMUM qualifier, 4-13, 4-23

/RELATIVE qualifier (RMS), C-6

/REMOTE qualifier, 4-18

REMOVE ACCESS_POINT command
(DFSSCONTROL), 2-14, 4-11

/REPORTING qualifier

SET COMMUNICATION command, 4-13

SET COMMUNICATIONS command, B-2

SET SERVER command, B-2

SHOW COMMUNICATION command, 4-23

SHOW SERVER command, 4-26

/REQUESTS_OUTSTANDING_MAXIMUM
qualifier, 2-3, 4-14, 4-23

RMS parameters

adjusting, C-1

on client, C-5

RMS-F-DNR error code, B-4

S

/SCAN_TIME qualifier, 4-14, 4-23

Security

See Files, access to

Server, 1-7

Session control port

disconnecting, 4-13

SET ALIAS PORT command (NCL), 3-10

SET COMMUNICATION command
(DFSSCONTROL), 4-12

SET COMMUNICATIONS command
(DFSSCONTROL), B-2

SET EXECUTOR command (NCP)

ALIAS NODE parameter, 3-9

MAXIMUM LINKS parameter, C-4

SET OBJECT command (NCP), 3-10

SET RMS_DEFAULT command (DCL), C-5, C-6

SET SERVER command (DFSSCONTROL), 4-15,
B-2

SHOW ACCESS_POINT command
(DFSSCONTROL), 4-17

SHOW CLIENT command (DFSSCONTROL),
3-4, 4-20

SHOW COMMUNICATION command
(DFSSCONTROL), 4-22

SHOW DEVICE command (DCL), 3-3

SHOW SERVER command (DFSSCONTROL),
4-25

/USERS qualifier, 2-21, 3-11

SHOW VERSIONS command (DFSSCONTROL),
4-29

SHUTDOWN COMMUNICATION command
(DFSSCONTROL), 2-21, 3-11, 4-30

SNAPSHOT CLIENT command (DFSSCONTROL),
4-31

SNAPSHOT COMMUNICATION command
(DFSSCONTROL), 4-32

SNAPSHOT SERVER command (DFSSCONTROL),
4-33

/SNAPSHOT_FILE qualifier

SHOW CLIENT command, 4-20

SHOW COMMUNICATION command, 4-23

SHOW SERVER command, 4-26

SNAPSHOT CLIENT command, 4-31

SNAPSHOT COMMUNICATION command,
4-32

SNAPSHOT SERVER command, 4-33

SS\$ ABORT error code, 3-7, 4-36, B-4

SS\$ DEVNOTMOUNT error code, 3-8

SS\$ INCVOLLABEL error code, 2-15, 3-8, B-4

SS\$ INVLOGIN error code, 3-8

SS\$ NOACLSUPPORT error code, 3-6

SS\$ NOLISTENER error code, 3-8

SS\$ NONLOCAL error code, 3-6

SS\$ UNREACHABLE error code, 3-8

START SERVER command (DFSSCONTROL),
4-35

Startup

DECdfs, 3-11

Station name

how to show, C-2

/STATUS qualifier

SET COMMUNICATION command, 4-23

SHOW SERVER command, 4-26

STOP COMMUNICATION command

(DFSSCONTROL), 2-21, 3-11, 4-36

STOP SERVER command (DFSSCONTROL),
4-37

Swap files, 1-2

SY\$GETDVIW system service routine, E-1

SYSGEN parameters

modified for client, 3-1

modified for server, 2-1

SYSTARTUP_V5.COM, 1-14

SYSTARTUP_VMS.COM, 1-14

SYSTEM account

printing server files from client, 2-7, 3-5

/SYSTEM qualifier, 3-9, 4-9

System startup file

DECdfs, 1-13

OpenVMS, 1-14

SYSTEM-F-DEVNOTMOUNT error code, B-4

SYSTEM-F-NOLISTENER error code, B-4

SYSTEM-F-UNREACHABLE error code, B-4

T

Transport connection

defined, C-4

Troubleshooting

obsolete logicals, D-1

obsolete qualifiers, D-1

U

UIC

discrepancies between client and server, 2-5,
3-5

User identification code

See UIC

User name, on client and server, 2-6

/USERS qualifier, 4-26

V

/VOLUME_NAME qualifier, 3-2, 4-9

W

Wildcards in file specifications, F-2

/WINDOWS qualifier, 4-10

X

XQP programming restrictions, F-2

